

Model radio control CARS



ISSUE No. 15

Price 60p. \$1.50 (US)

DM3.50 Fr. F6 Glr. 3.50 SF 3.00

R/C CARS Ted Longshaw for Service & Experience



JUST 'PHONE YOUR
NUMBER THROUGH

9 YEARS INTERNATIONAL RACING
EXPERIENCE IS AVAILABLE
TO HELP YOU!

MODELLERS!

Interested in R/C Cars?? Send for our 1980 Catalogue 75p.

We have the largest stocks of $1/8$ and $1/12$ Scale Kits and Spares. Mail Order despatched same day. All major manufacturers products ex-stock. Phil Booth specials for the P.B., McCoy Mods. Phil Booth tuned engines.

One source for ALL your needs!

DEALERS!!

Can we help you? We are distributors for PARMA, P.B., DELTA, BOLINK, THORP, UFRA, McCOY.

Thousands of $1/8$ and $1/12$ tyres in stock, hundreds of bodies. Parma paint, motors, tyres, etc., etc.

Try us — normally one order will bring all your requirements. If it's available we've got it!

Mail Order Only Address (no stock held here) European Export No Problem. Trade Enquiries Welcome.

80 PEPYS ROAD, LONDON SE14 01-639 5080

RADIO CONTROL

radio control MODEL CARS

Published by L-D EDITORIAL - TECHNICAL SERVICES LTD., P.O. Box 30, HEMEL HEMPSTEAD, HERTS. HP1 1NL. MARCH 1980.

Editor: "Dickie"
Laidlaw-Dickson

START OF THE NEW SEASON

What treats and what amazing new revelations are in store for us during the outdoor season now before us? Rumours galore of multi-gear devices, FWD for $1/8$ th scale, springing back again, fantastic speeds — you name it someone will tell it to you. One thing I can say with certainty it was not on show at Nuremberg! Anything to come is being kept well under cover until at least the Monaco Cup meeting in June. But on other fronts there is every evidence of a grand season before us.

BRCA membership at the four figure mark betokens a thriving hobby. The overlap of BRCA and BRECA membership lists indicates that the two scales are far more intermingled than the pundits led us to believe. The growing " $1/8$ th invasion" of the electric field shows that the fascination of driving a little car is not entirely a matter of noise and smell. Results lists indicate that skills too are widely distributed with the acknowledged experts in both scales well mixed in finals order. I am also getting quite a lot of enquiries from electric drivers about starting off this season on $1/8$ th.

Where is the inevitable question. New clubs are springing up every week with quite modest aspirations of racing on a used car park at weekends, with very encouraging responses from commercial and factory directors in permitting such use. Local authorities in spite of widely publicised economies are apt to lend a friendly ear to proposals. So do not be bashful in approaching authorities... soft words do indeed butter a lot of parsnips!

Purpose built tracks represent another facet of the scene. Here a great deal of

effort by club members is required and a fairly strong nominal roll of willing shovels. Four new purpose built circuits are likely to be holding inaugural meetings this season with Aberdeen introducing Scotland's first permanent circuit Mineralwell Park at Stonehaven; West Burton, near Retford in the grounds of the power station and home track of West Burton R.C. Club; Lambton Park — circuit of the North East R/C Car Club in the Gateshead district; and coming further South Aldershot are completing a very fine circuit with much sweat and toil. A further circuit is taking shape near Preston and should be open later in the season in stage one with a lap length of 175 yards, to be followed on completion with a total length of 275 yards, and a variety of alternative layouts. All of which is very much to the good. On the other side of the coin, however, we must bid farewell to Catfoss at Hull where encroaching industry has overrun them at last; whilst a shift of local interests leaves Newbridge, Wes Raynor's first in Britain circuit, unused and decaying. Leyton Raceway has also as reported fallen to the developers leaving the London club a "nomad" body but on good visiting terms....

UP TO DATE CLUB LIST

There is a really urgent need for an up to date club list, saying who is secretary, treasurer etc., with addresses and telephone numbers, details of what is race, i.e. and electric, or just the one, what sort of a circuit is available, or hall or gymnasium or what, whether members welcome or waiting list (yes, there are some clubs like that!) and how much the subscription is. In fact anything useful. Our own magazine feature tries to cater for the new clubs but I know there are a great many unrecorded,

CONTENTS: EDITORIAL .. 3 CLUB & TRACK REVIEW .. 5
"WINTER NATS" ELECTRICS AT EXTER .. 10: MRP PRO-180 ..
15 RACING CALENDAR 1-8 .. 19: GRP BODY FOR THE FORCE ..
22 STOCK CAR RACING CALENDAR .. 25: GETTING THE BEST
OUT OF YOUR NI-CADS .. 30: GRAUPNER FWD CAR .. 34 OS 21
MAX .. 38: GETTING IN LEAGUE .. 39 SHOPPING AROUND AT
NUREMBERG .. 43 STOCK CAR ENGLAND CHAMPS .. 50.

15

MODEL CARS

3

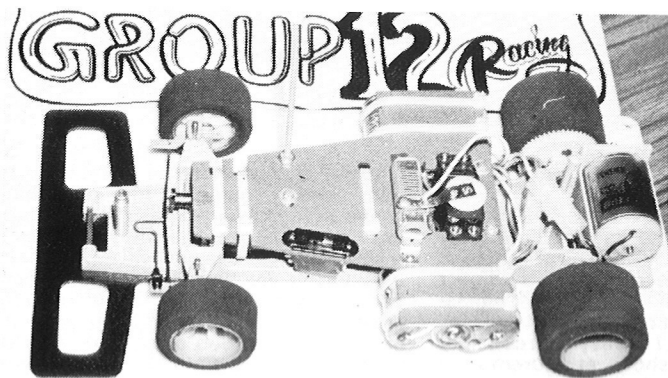

The standard Group 12 electric car made up of the products of a consortium of U.S. manufacturers so no one of them can claim the glory for a win. A "peoples' car?"

and changes in secs etc are not always passed on. BRCA regional officers are also doing their bit in gathering information. I do not know if this will appear as a BRCA publication or as something based on this magazine, there will probably be a small charge for it if it gets bulky enough to cost real money but have it we really must.

GROUP 12 FOR THE ORDINARY DRIVER

A very nice little scheme is a wheel in America the introduction of a class for the not so expert driver who just wants a friendly race: Group 12. This is for electric racing and is the brainchild of a consortium of U.S. manufacturers. It offers a car made up of parts from several sources that is only eligible to race straight out of the box. No alterations are permitted, and no sponsored or professional driver is eligible. In the same way the consortium has agreed that no advertising claims of "my motor" or "my steering" won at Indianapolis or whatever, so there would be no incentive for pro-drivers to participate. This it is hoped will provide pure skill as the winning factor, plus a bit of luck of course. After all you win at golf with standard clubs and no magic except skill don't you? I hope it works and slows down the process of more and more expensive accessories to achieve victory (I still think money is unable to inject skill only buys "hired assassins").

INTERNATIONAL SCENE

ERFA Newsletter reports that official American works entries for the Monaco Cup are unlikely as there are counter attractions in those parts over the race period including Indianapolis 500 Race and a Can-Am event for r/c drivers on the

West Coast. However, there are fifteen places allocated and some quite new independents may be expected to show their paces. With a World Champs due to follow in 1981 on American soil it might be a wise move to try out the current opposition after the surprises of 1979.

With the Euro Champs this year in Gothenburg the Danish Hillerod Club are putting on a meeting for August 2/3 to tempt drivers going up via the Baltic ferry.

Ferry costs about £10 return, including car, £16 plus trailer, boats go every 20 minutes or so, no need to book in advance.

If you are interested write: RC Model Centre, By Ole Harder, Torholmsalle 6, Tulstrup 3400 Hillerod, Denmark.

A GERMAN BREAKTHROUGH

Congratulations to the German model car magazine *auto-modell technik* on going monthly. The magazine started about the same time as this one also on a bi-monthly basis but their publisher Attila von Sandor was always optimistic of an imminent monthly change much fortified by his impressions of the Geneva meeting and lo and behold as promised January saw it on a monthly basis. Not enough to go in was always the pessimistic view, not enough interest said others, but it can be done. Very special and friendly good wishes to the editorial team: Heiner Martin, Technical Editor and Hans-Ludwig Walter, Sports Editor plus their assistant whom I have not yet met.

In case you fancy a copy (in German but beautiful pictures and articles worth working out with your little Hugo) address is: Verlag fur Technik und Handwerk GmbH, Fremersgergstrasse 5, 7570 Baden-Baden, West Germany. Cover price DM3.50 plus postage, so sending about £1.00 should be just right.

CLUB & TRACK REVIEW

The outdoor season is opening in a moderate blaze of glory with four new purpose-built permanent circuits in operation or shortly staging a welcome meeting, plus a fifth well on the way to finish first section useable this summer. Southern League will by now have run its first round at Taunton on March 23rd; with Aldershot hosts in May on their new track. Overseas visitors will have an opportunity of seeing the wonderful new track opening near Innsbruck at their EFRA meeting in September. More and more 1/12th scale electric clubs are springing up with a welcome intermingling of drivers from 1/8th scale. It is just a little tight to report on the Jim Davis Spectacular which was originally billed for the Exhibition Centre Hall 6 at Birmingham but had to be switched when the exhibition people booked the date elsewhere to the more centrally placed Bingley Hall a fortnight earlier. This I think was a good thing, the Centre is really just too big for models!

Aldershot Model Club

Secretary: Tom Hamilton
Cross Farm School (Tel: Deepcut 5842)
Gresham Way, Frimley Green
Camberley, Surrey.

After three years service George Yarborough has stood down as secretary of Car Section and hands over to Tom Hamilton as above. Meetings on the new circuit include a National Benzole Invitation event on June 1st, a BRCA meeting 19/20th July and an Invitation event on October 19th. On the construction front club members moved some 80 tons of earth without mechanical aid (to say by hand might be misleading) and contractors then moved in to lay foundations and tarmac. Flush toilets and other delights – landscaping etc – will be available. Congratulations on a splendid achievement!

Stockcar Racing England

Secretary: Paul Dudley
Moat House Works,
Kings Coughton (Tel: 0789 762519)
Nr. Alcester, Warks

The former Studley Model Racing Association which staged the recent Open European Stock Car Champs (reported in this issue) will now be known as Stockcar Racing England. This follows talks with Stockcar Racing Holland, Stockcar Racing Belgium as well as Italian drivers and

several British clubs. It now becomes part of the European Stockcar Association. This body will work to form a common set of rules to suit all makes of cars and engines and produce a Racing Calendar so that major events such as "World's" "Euro's" "Internationals" are hosted by each club in turn on a truly international scale. Further information on this fast growing association together with calendar of events can be obtained from Paul Dudley, as above (SAE please)

Sussex Electric Car Club

Secretary: Bill Owen
16 Bridgemere Road
EASTBOURNE (Tel: 0323 29028)
East Sussex BN22 8UB

The club is still going very strong with thirty-five active members and new members joining at each meeting. Racing takes place fortnightly as usual on Sunday mornings at the Polegate Community Centre, Windsor Way, Polegate, Near Eastbourne. Membership costs £3 p.a., Juniors half-price, with a 50p race fee. The club now has its own lap counters and regular trophies at all meetings. Local model shop Roberts Models Ltd has donated a fine K.O. cup. Kevin Morley (Tonbridge) took the 1979 Championship by one point from Hastings man Gary Kennedy, which gives some idea of club catchment area. A sponsored one-hour event on 30th March will be in aid of the Community Centre extension fund (which when duly extended will give the club another 20 feet of racing area. Charity indeed begins at home!)

Cleveland R/C Model Car Club

Secretary: Ken Rigby
1 Topcliffe Road
Thornaby (Tel: (0642) 583244)
STOCKTON-ON-TEES Cleveland

The Cleveland club previously listed as "Thornaby" will be running a 1/12th Electric Grand Prix as a National Open Event on 11th May at Thornaby Pavilion, Thornaby, Stockton-on-Tees. This is being organised by Sec Ken Rigby and Dennis Trowbridge (the man who has sprung surprises on the experts in both 1/2th and 1/8th racing!) as Race Organiser. All races 6 (six) minutes. Practice starts at 8.30 a.m. Three heats, Open Final, two handicap finals with at least eight awards for each final. Eight car heats; timing to 1/100 second, courtesy L & M Electronics who are

lending a micro-processor controlled lap counter. The Pavilion is a large leisure complex on outskirts of Cleveland County about 1/2 mile from A19: turn off and head for Thornaby Town Centre. This promises to be an exciting event at a new venue with room for 96 drivers (12 8-car heats).

Andover R/C Electric Racing Club

Secretary: C.D. (David) Godfrey
33 Springfield Close (Tel: Andover 62950)
ANDOVER, Hants SP10 2QR

Now a formal club with eighteen members, all keen and enthusiastic and at driving skills of all levels. A warm welcome will be extended to newcomers. Meetings (Winter) Longmeadow Hall, Cricketers Way, Andover Wednesdays 7.30 - 10.30 p.m. Special thanks are extended to the Swindon Club who attended the inaugural meeting to offer advice and experience.

Tameside Radio Model Car Club

Secretary: Roy Johnson
54 Urwick Road
Romiley, STOCKPORT
Cheshire SK6 3JP

The club is now well established in 1/12 scale electrics with fifty plus members holding weekly meetings on Wednesday evenings 7-10.30 pm at West End School, William Street and on Sundays from 2-7 p.m. at the T.A.V.R. Drill Hall, Cavendish Street (Just behind Lex showrooms), both venues in Ashton-under-Lyne, Lancs. TAVR Hall is main circuit with a 100 yard plus lap length and a 40yd. straight, providing one of the best tracks in the North West. Club comps take place on last Sunday of the month, with scratch, handicap and junior trophies to be won. Interested parties contact secretary to arrange a visit and/or membership.

Radio Stock Car Leicester

Secretary: Stewart Busby,
72 Rosamund Avenue (Tel 898683)
Braunstone
Leicester

First year as a club has been pretty successful with current membership of seventy-nine. Tragic death of Steve Richardson marred the scene. A collection raised over £100 and the club has bought a really splendid trophy in his memory for annual competition. Winner in '79 was Bob Clayfield. Other trophies have been introduced thanks to local firms' support. Club drivers have attended most of big open meetings this year, with Steve Talbot recording a win at "World" Event at Keighley, four other drivers made that

final as they did at the Crystal Palace charity meeting. Southern Fiesta meeting saw Dave Wragg again taking first place. Fixture list for 1980 should be out by now and distributed to members.

South Birmingham Model Car Club

Secretary: Tony Stephenson,
522a Haslucks Green Road, Shirley,
SOLIHULL,
West Midlands

The club is now in its second year and attracts a good turnout each Friday evening with a wide band of drivers from championship level to novices. A league now operates with three classes giving everyone an achievable goal whilst still offering both experienced and novice drivers a good night's racing. Membership is on the increase but new members are still very welcome. Apply secretary as above or to his business number (Hobby Spot) 021-4221000. It is hoped that an inter club league or challenge series can be arranged in the Midlands. Any clubs interested in the proposal are invited to get in touch with Tony to talk things over.

Preliminary notice is also given of running a summer national event for 1/12th scale cars. It will take place at the Malvern Winter Gardens, Malvern, Worcs on Sunday 13th July 1980. Superb racing facilities plus the beautiful gardens with lake and other attractions. Valuable prizes and trophies for first six places in the open event, trophies for first four teams and a concours trophy for the most attractive car racing. Entry forms and further particulars again from Tony as above.

AREC (Administration of Radio Controlled Electric Cars)

Secretary: Dave Williams
PO Box 1202 Gisborne
New Zealand.

Dave Williams has written to introduce the above group which has been formed to control electric car racing in New Zealand. Rules are basically as ROAR with the exceptions that reverse is mandatory, skirts are allowed if fitted to fullsize prototype, and that variations in bodies, airfoils, wheels and tyres are allowed if documentary evidence produced that car is to scale of a fullsize prototype. AREC is very concerned that scale should be adhered to pretty rigidly and would like to think that ROAR and EFRA are equally scale minded. A track marking suggestion is also of interest: They have found the best way of marking out their circuits is nylon rope of at least 13mm dia., and preferably bright yellow.



Gemini

COMPETITION 1/12 SCALE R.C. CAR
DESIGNED BY PHIL GREENO

Winner of both Saloon and Sports Car Events at British Winter Nationals Exeter 1980

FEATURES

- GRP Countersunk Chassis
- GPR Radio Plate
- Lightweight machined alu. axle blocks with adjustable motor mounts
- Ball-raced Rear Axle
- Schumacher Differential with Quick Release Wheels

- Lightweight Front Suspension with Akerman steering
- Lexan Body and Adjustable Wing Wire Set
- 6-cell Ni-Cad Pack and Charge Leads
- Race proven Winning Success

- Adjustable Body mounts front and rear
- Available with Indoor or Outdoor Tyres
- Very high construction quality for reliability
- Designed to fit BRCA ROAR and EFRA Rules

KIT PRICES

PGE 1201 BASIC ROLLING CHASSIS Kit only, contains all hardware but no Ni-Cads, motor, body, charge leads, etc.

£49.95

PGE 1202 COMPLETE KIT includes motor, Ni-Cads, charge leads, Lexan body, and wing, Suspension parts, body mountings

£77.00

PGE 1203 "COMPETITION SPECIAL" as above but comes ready built, includes lightweight comp. chassis, painted Lexan body and wing wire set, Parma Renault 05 motor (BRCA, ROAR legal)

£85.00

"ADAMS DEMON" SPEED CONTROLLER

Electronic Speed Controller with fully proportional forward speed and dynamic braking. Plugs into Receiver, regulated 5-volt supply eliminates Rx battery and throttle servo. Very high construction quality. Proven reliability

Available in two versions

PGE-DM1 Proportional forward with dynamic brakes £34.50

PGE-DM2 Proportional forward with dynamic brakes and reverse £39.95

ALL PRICES INCLUDE VAT

EXPORT AND TRADE
ENQUIRIES WELCOME
AVAILABLE AT ALL
LEADING MODEL SHOPS

ACCESS - BARCLAYCARD - HOBBYCARD
PLUS FAST MAIL ORDER

Manufactured and Distributed by

PHIL GREENO MODELS LIMITED

9 VILLAGE WAY EAST, RAYNERS LANE,
HARROW, MIDDX. HA2 7LX. TEL 01-866-7770

SANWA DIGITAL PROPORTIONAL RADIO CONTROL SYSTEMS



**Every
picture tells
a story!**

**If you would like
a further dialogue on
IRVINE-SANWA products, please
contact your local dealer, or,
send large (A4) S.A.E. to:—**

**IRVINE ENGINES LTD.,
TRIAL PARK, BRUNSWICK WAY,
NEW SOUTHGATE, LONDON N.11**

Keith Plested, Managing Director of P. B. Products, Havant, says:
"MacGregor & P. B. Products decided to combine their talents
in order to develop a new two channel system for car racing.

The results were most impressive
as it allowed an improved driving technique
giving a distinct advantage under
racing conditions."

A WINNING COMBINATION

The MacGregor MR 1222 ASN/2S special
incorporating the new MR 12T high torque
servo and the International from P. B. Products.



Designed for the improved
sensitivity and power necessary for
controlling high performance
models.

Available in all good model shops now.



MacGregor Radio Control

Canal Estate, Langley, Slough, Berkshire SL3 6EQ
Telephone: Slough 42251

**STOP
PRESS!**

To All Retailers: MacGregor are
now distributors for P.B. Products

Join SMAE—the modellers safeguard Tel. 0272 48869

MODEL CARS

"WINTER NATS" ELECTRICS AT EXETER

REPORT BY LES PIPE

Twelve months have elapsed since I last travelled the M.5. to Exter for the East Devon Radio Car Club's National Open Meeting. As expected an even larger number of drivers appeared after last years successful meeting. The meeting was held at Exeter's St George's Hall, which is situated in the heart of this fine city. This years event was extended to a two day affair. Saturday saw a saloon car event called the Tamiya Trophy race during the day, and a meeting of drivers from the Western area qualifying for places in the Sunday's meeting was for G.T. cars, running for the Ripmax trophy, for the Ripmax trophy.

There was a number of well known figures from the 1/8th scale world (as at the Bradford meeting at the end of last year) competing in this event. Phil Booth appeared driving for the Associated Team, along with Dave and Debbie Preston and Wal Bailey. Phil Greeno was running for the Ally Pally Team. It was nice to see these faces I think we managed to give them a good 'run for their

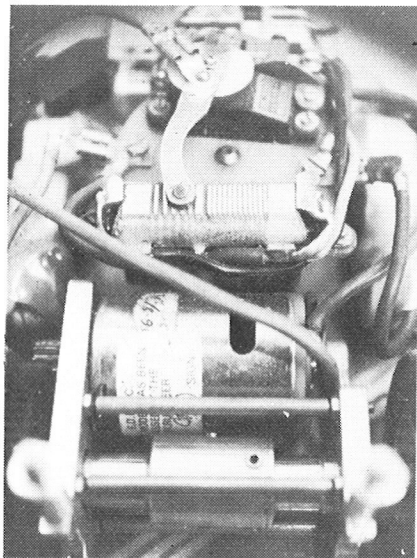

Neal Francis's power set-up. Like so many leading drivers he favours a Parma resistor type speed control.

Below: Phil Booth's works Associated RC12E car — again with resistor speed control & micro switch operated reverse.

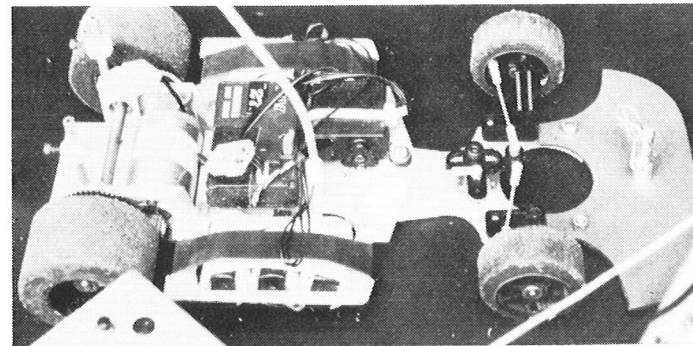
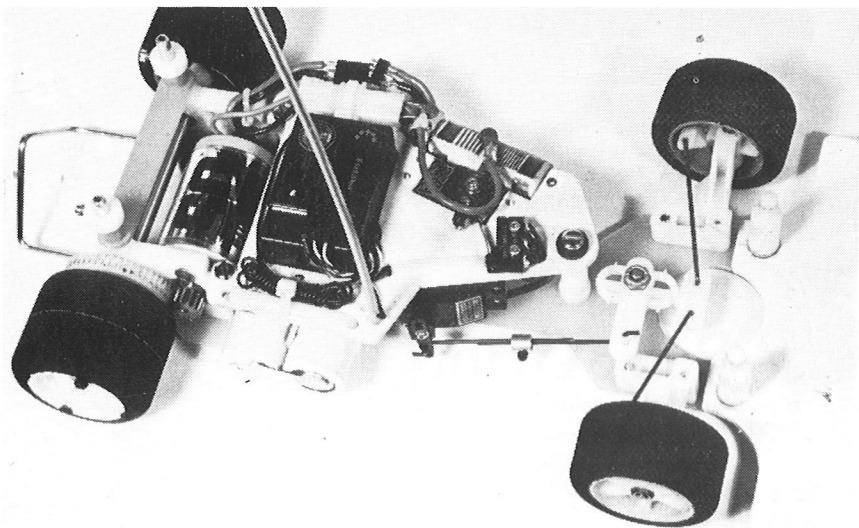

Nick Adams Greeno "Gemini" car with latest Demon propo. speed controller.

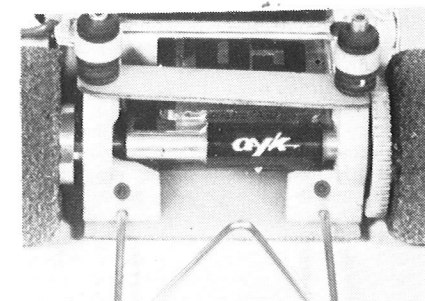
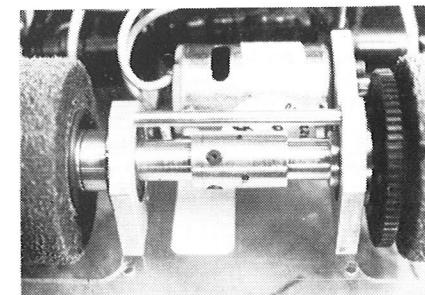
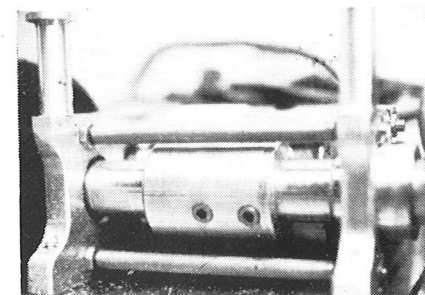

money! Most of the well established teams appeared again for the first of the new year's battles Spectron, Jim Davis Models, Ally Pally, Alpha, Petra. Two of the members of the old Modelcraft Team are now running for the newly formed Hobby Spot team, and so were presented with a new challenge. New names on the team list included Ripmax and Associated. The latter team's cars were highly modified compared with the kits but excellently turned out. I'm told all the paint jobs were done by Wal Bailey (who won the Concours on both days). The chassis have had a neat job done on them in the interest of lightening the cars. A very neat diff. was spied in Wal's car for a short while. I'm reliably informed (by 'big' (Jim Davis) that they have an oriental origin and that he will probably be supplying them in the not too distant future?

Saturday's racing got off to a good start with about 60 to 70 drivers all r'aring to go! Everyone seemed to get some practice time without the usual hassle. At around 10 o'clock a halt was called for the drivers' briefing and then the meeting was under-way.

It immediately became obvious that last year's winning times were going to be completely squashed and squashed they were! The fastest time this year was 24-19 (achieved by Neal Francis), eight laps better than last year's fastest time. This was a real eye opener for me, because I won last year's meeting after putting in a blistering 16 laps! and I thought I was flying!!

Close-up of Neal Francis' diff.

Then for contrast the much smaller one that fellow finalist Bill Maisey uses.

Even smaller yet! This is Walt Bailey's Japanese "ayk" diff. He likes it and hopes to be importing some.

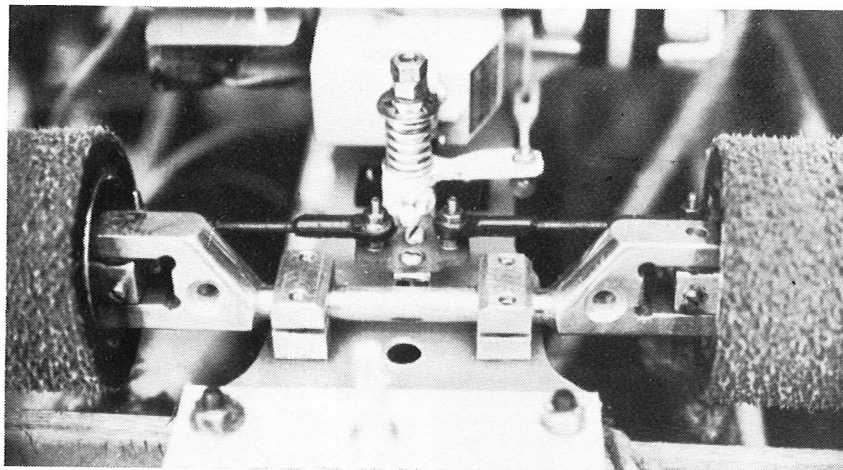

Phil Greeno was the only driver to challenge Neal's figure but he didn't quite make it although he was fast enough to qualify to go straight into the final on both days.

The qualifying heats went according to plan with the speed of turnover between heats being super efficient. The rule for 30 seconds max. between heats was stuck to rigidly and this made for a very efficiently run meeting. A word must be said here for the team of lap counters and officials. They did a marvellous job!

After the qualifying heats, the 12 fastest drivers were split into 2 semi-finals. These were split evenly so as not to put all the fast cars in one semi, making it a simple job of taking the first and second cars from each race for the final. We eventually ended up with a final line of Neal Francis, Phil Greeno, John Chamberlain, Tom Morgan, Dave Preston and myself. Phil got the break and was never to be bettered despite Neal's gallant attempts.

Sunday's racing was very much a copy of Saturday's, with practice going on very smoothly despite the larger entry. Although there were more drivers competing the times did not differ much from Saturday's times..... proving that our body shells are not as critical as 1/8th scale racers. Neal put in a 25-05 with his G.T. bodyshell, which was a lap better than his saloon car race the day before so maybe there is something in different bodyshells making the car perform in different ways???? Phil Greeno again proved he was very fast by clocking a good 24 lapper, but even with all his selec-

Something new! John Varley's variable castor axle beam.

tion of motors (passed by the scrutineer of course!) and rather nice facho borrowed from Nick Adams, he could not find the necessary power to top Neal's fastest time. The qualifying heats took longer on Sunday because of the large number of drivers. We eventually arrived at the semis, following the same format as Saturday. Both the semi finals were hard fought battles. After a lot of very fast racing and skilful driving we had six finalists consisting of Neal Francis, Phil Greeno, Bill Maisey, Phil Booth, Tom Morgan and Debbie Preston. Again, Phil Greeno got the break (a credit to his super reflexes and Nick Adams' speed controller which punched the car quickly off the line). The pursuing pack made things difficult for themselves by piling into one another at the first corner, thereby letting Phil get clear. After building a comfortable cushion for himself he then only had to pace himself to the end. Bill Maisey took up the challenge to chase Phil in second place, with Neal hot on his heels. It proved to be a very exciting race enjoyed by all.

Phil Greeno's car, still the prototype he ran at Bradford, now has a name..... Gemini..... and is soon to be boxed and ready for the shops. Phil tells me that he took the best points from his Monaco winning 1/8th scale P.B. car and miniaturised them for this superbly turned out electric racer. The car also included Nick Adams' new Demon electronic speed controller now sporting reverse. The latter with reverse is

still in prototype form, but if the weekend's performance was anything to go by, it should be excellent. I think Nick will be testing his controller a little longer yet though, just to make sure. I don't think Phil used it more than a couple of times in reverse all weekend!

Diffs. seemed to be the order of the day. As I looked round the pit area, most cars sported some kind of split back axle. Cecil Schumacher's limited slip diff. probably accounted for more than half the diffs around. An increasing number of home made diffs were to be seen. These mainly differ (sorry!) in exterior appearance only. It is surprising how they are able to get the gears into such small external cases..... as illustrated by Bill Maisey's diff. against Neal Francis's. Although Bill has had trouble with his very small gears stripping teeth, it performs very well.

Most cars seem to be running on Armaflex or equally soft compound tyres. Most people seem to have got to grips with silicising their tyres now. A lot of people found it necessary to re-silicone on the day as the track surface was fairly abrasive. I found that my tyres were only good for one race then a fresh set was required. A lot of other people had the same problem.

One of the main spectator highlights of the weekend was a motor bike demonstration. It was very entertaining, but I think it

is going to be long time before we see them being raced competitively. A very interesting display, however,..... obviously a lot of hours had been spent in preparing the bikes and it was manifest that the skill required to operate them is not going to be gained easily. Congratulations to all those who attempted to circumnavigate the track..... a difficult task at the best of times even with four wheels, as many will agree, I'm sure!

Well, that just about wraps up the first National meeting of the new year. A terrific weekend was had by all. A big thanks must go to Giles Jackson and his splendid band of willing helpers. I'm sure it would be hard to fault any of the organisation of the meeting which went ahead without any hassle or unpleasantness..... (something that tends to creep in on these big occasions when everyone is so uptight with racing). We hope Giles and Co will try for a third Exeter meeting next year..... We'll all be back. The unsung heroes (i.e. GILES & CO) triumph again! Well done again. Looking forward to next year.

Results:

- 1st Phil Greeno (23 laps), 5:4.5
- 2nd Bill Maisey (23 laps), 5:14
- 3rd Neal Francis (22 laps), 5:0.5
- 4th Phil Booth (22 laps), 5:9.5
- 5th Debbie Preston (22 laps), 5:13
- 6th Tom Morgan (21 laps), 5:6

Fred Hatfield sported this super-light chassis.

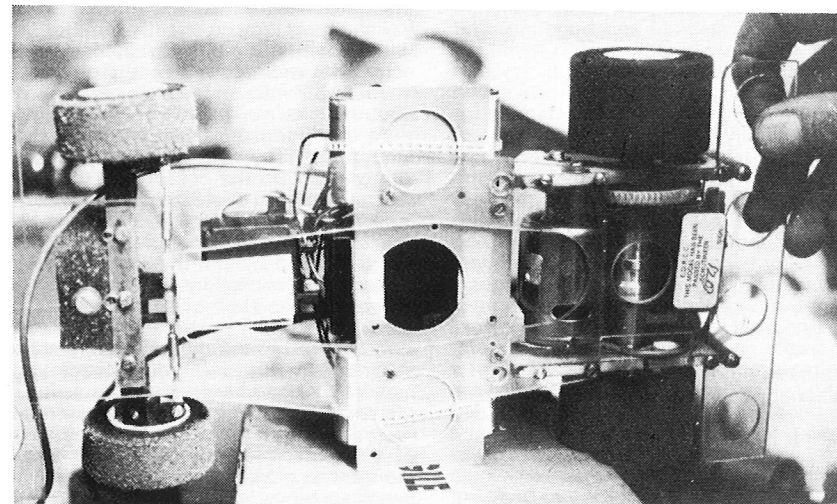

TECHNICALLY SPEAKING

BY GILES JACKSON

Technically the cars were as interesting as ever. It is evident that the nicads should be mounted independently from the chassis and all the quick drivers had them on some sort of shaker plate. The J.D.M. cars were particularly innovative. They featured a very long wheelbase (8½") polycarbonate chassis. They had an alloy differential and rear blocks made by Tom Morgan. These were so frictionless, that with the car clear of the ground, you could spin one wheel and the other would keep spinning in the opposite direction for 10 or 15 seconds. Incidentally Tom reckons a replica would cost about £85! This rear end, plus carefully selected motors contributed to the cars being the fastest in a straight line. Like several other teams, J.D.M. used a Parma speed control with micro-switch reverse that gives no power loss at full speed and they also used a 6v 225ma deac for the receiver.

Team Associated was run by Walter Bailey and the cars were especially sent out for the event. They were extremely light and featured a new Associated diff that works on the same principle as the Schumacher, although Dave Preston's car featured a Japanese AYD unit. Although significantly different from the standard RC12E, this car will be available shortly.

Phil Greeno's car was his standard kit and everyone driving one commented on their superb stability and handling. Phil used the Igarishi 303 motor from the Graupner front wheel drive car. He also had a reverse fitted to his Demon speed controller which is quite a departure for any Ally Pally member.

Quite a large number of front wheel drive cars were seen and while very competitive on a small dusty circuit they are completely at sea on the larger tracks suffering a lack of straightline speed and instability at speed. They were all noticeably weaving at the end of the straight.

On the subject of motors, the banning of the Red Spot (25 wind) motor causes considerable headaches for scrutineers. Average motors are easy to detect but a tightly wound 30 wind standard which are the ones that go better of course, look very similar to the Red Spot. Quite a large number of the black end bell RS540s, as found in the Tamiya jeep were seen, which combines the best attributes of both but

being a 27 wind motor it isn't strictly legal either. The only real answer is to increase the race times to about 7-8 mins and allow any unopened motor, factory rewinds excluded.

There was much discussion concerning batteries. Sub C sized cells are now available up to 1.6 ah and we may be forced into the situation of the Americans where R.O.A.R. rules now only permit G.E. 1.2 ah cells. Interestingly if you take a so called 'standard' Saft cell and recycle it a few times it quickly comes up to the level of a 'selected' cell. Enough said!

The secret of obtaining long battery duration in races is in proper care of the batteries themselves. In this respect it may be worth looking at the method employed by the Associated Team. Bear in mind that a good set of nicads (ie not overcharged ones!) should run a standard RS540 or an Astro for about 8 mins. A Red Spot will run for about 5½ mins. Unfortunately nicads have a memory so that if you only run 5 minute races they quickly acquire a 5 minute charge-discharge cycle and only work efficiently for those 5 minutes. Therefore as soon as the race is over it is imperative to continue to completely discharge the cells. only then should they be recharged.

It is most important that the cells do not overheat. They should not feel more than slightly warm to the touch. If they overheat gassing occurs, pressure builds up and the electrolyte, potassium hydroxide is vented from the cell. Each time this happens the cell becomes less efficient.

The Associated Team start by charging their nicads at a constant 4 amp rate. During charging they constantly monitor the voltage with a digital voltmeter. Voltage across the ends of the nicads should start at about 8.2 volts and rise slowly towards about 9 volts.

At this point they switch to a 2 amp charge rate. The voltage will continue to climb faster as the cells reach the fully charged state. At Exeter they were looking for a 10.2 volt reading at full charge but this figure will vary depending on the individual nicad pack and the external temperature. In the region of 9.7 to 10.3 is acceptable. As the voltage continues to climb towards its peak it should be constantly monitored until it suddenly starts to drop. At this point disconnect your nicads! Excess charge after this point is merely wasted as heat with the aforementioned unfortunate results. The advantage of a digital voltmeter is that the exact moment at which the voltage begins to drop can be very accurately ascertained.

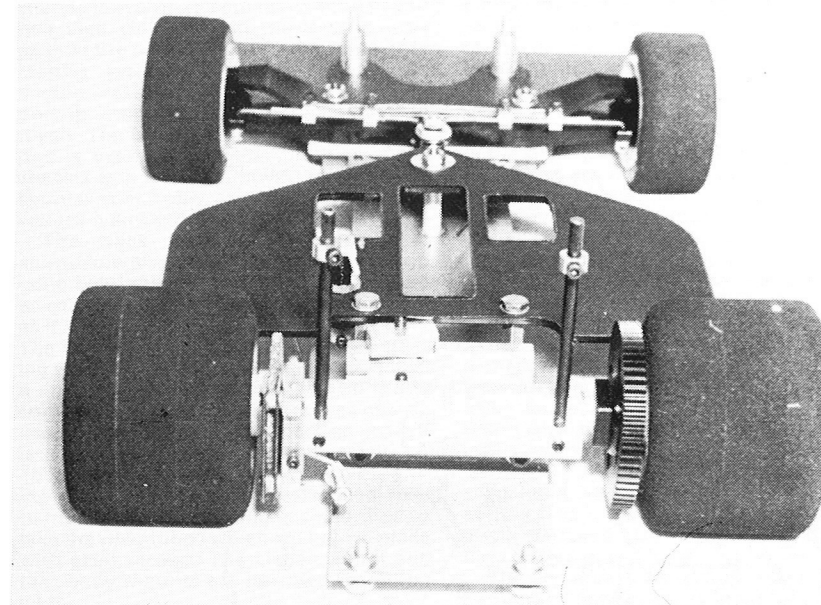

MRP PRO-180

Model Racing Products of America entered the model car scene in 1969 by marketing accessories. In 1972 they produced their first car kit – a dragster; followed in 1974 by their first racing car. Their latest 1/8th scale car is the MRP Pro 180 Expert which is available in several stages from a kit to make into a rolling chassis, i.e. no body, to a fully assembled car complete with engine and radio.

The kit under review is the MRP Pro 180 Expert de Luxe and arrives with the parts batched in numbered bags. These numbers are used to clarify the nine-page foolscap assembly instructions, so, providing the parts are kept together assembly should be easy to follow. However, if the parts get mixed up whilst being checked they can all be re-identified by the aid of the excellent exploded drawing.

The first noticeable bonus is that the tyres are already glued to the wheel hubs, or as the catalogues briefly describe "trued and glued" or just "t. & g." This eliminates the dreaded "glued-up hands." The introductory paragraphs of the instructions give general information and some sound advice applicable to any make of kit: "... assemble the car as shown. Later, when you have familiarised

**BUILT & DESCRIBED BY
NIGEL HEIGHTON.**

yourself with the characteristics of the chassis you might want to experiment with some ideas of your own." (*Rather different from the typical plan/kit assembler's initial comment "What shall we alter first?" Ed.*) The next paragraph recommends sorting out the front beam and boiling it in water, followed by roasting it in the oven – to give extra strength. Strange instructions, but having just read the previous notes, a visit to the kitchen is duly made. (*This procedure has been recommended to aeromodellers with plastic airscrews and by some other American kit manufacturers for certain plastic parts, usually steering cross beams and servo-saver parts. Some plastics do indeed benefit from the treatment and it should be carried out if advised by the supplier Ed.*)

Bag No. 1 contains glass fibre chassis, engine pod and axle pod. These latter two pieces give notice that the car is obviously designed very differently from the usual kit cars that one sees at most race meetings in England. The cast aluminium engine pod has a recess and lugs. so

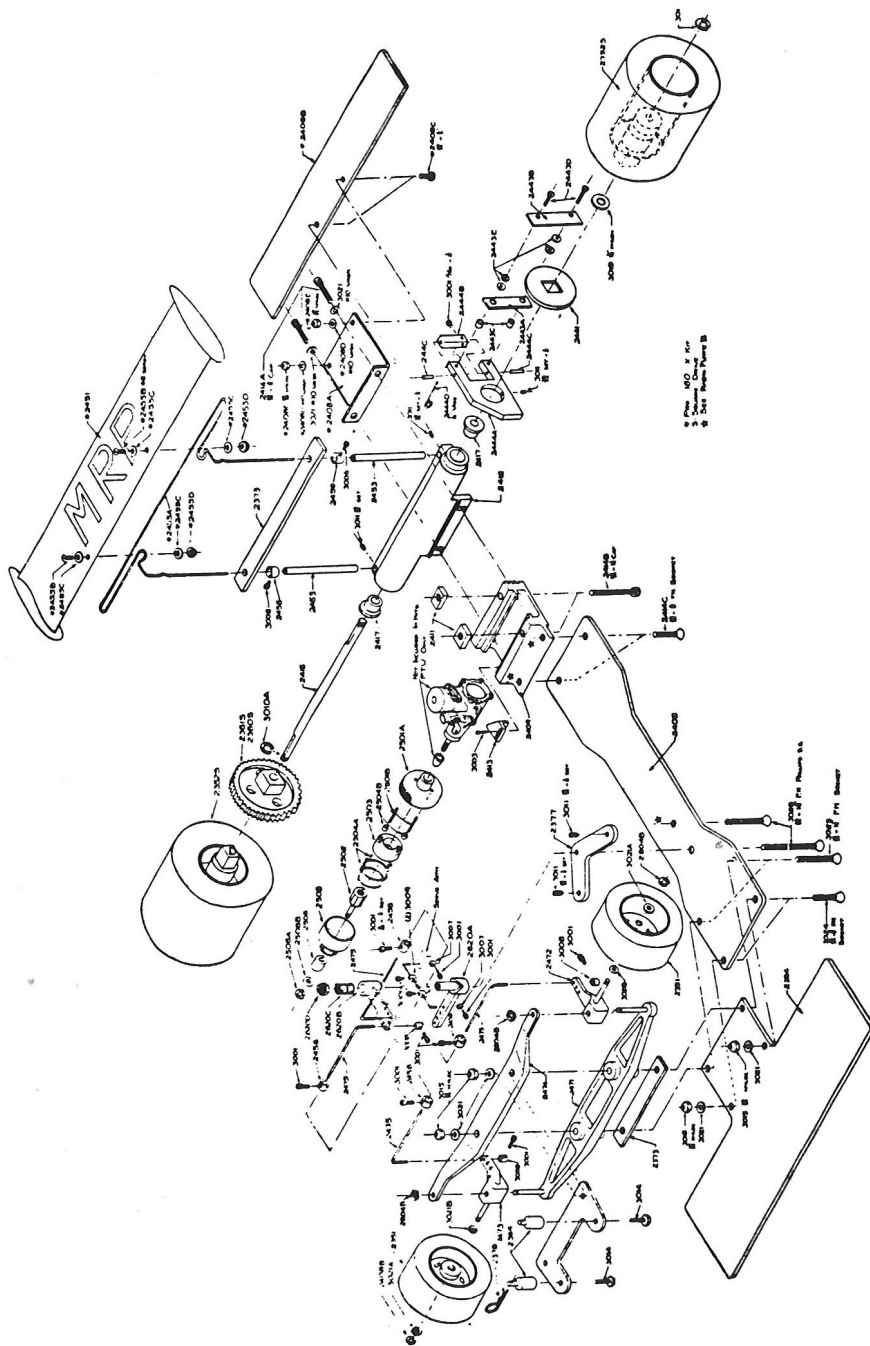

shaped that a 19-21 engine is a snug fit and two side clamps hold the engine lugs against the pod lugs. A nylon engine gear locking wedge is fitted between the engine crankshaft housing and the engine pod to make sure the engine stays in mesh. The front underside of the engine pod is machined so that the glass fibre chassis is a flush fit, bolted in place via counter sunk holes, as are all the holes, to ensure a smooth fit.

The back axle pod is also cast aluminium and in standard trim has plain oilite bearings, but ball races are offered as an extra. The axle pod is rather unusual as it mounts to the back of the engine pod. The joint is vertical. The engine pod trailing edge has three horizontal grooves and a lip is cast on to the axle pod so that a combination of ground clearances can be used depending on which location groove is used. The same fixing bolts retain an "L" shaped plate that provides a mounting place for silencer dustbin and rear bumper. The axle casting is pre-drilled to take the wing tubes which are held in place with grub screws. The Llexan airfoil and rear body mounts are included for fitting later.

The disc brake unit clips on to the left hand side of the axle tube which has been reduced in diameter to match the hole in the brake bracket. The operating cam is square with pivots top and bottom. The brake shoes are bolted on to the disc bracket with shim washers to obtain correct clearance between the disc and shoes. The disc is located by a square driving extension on the rear wheel hub. The

extension on the other rear wheel fits a recess in the drive gear thus completing the back axle assembly. The wheels are held in place with circlips whilst flats on the axle and in the hub give the drive.

The front wheel stub axles are fitted to the two-piece front beam now safely out of the kitchen and much to my wife's relief no smells are left in the oven pans! The front beam mounting bolts also hold down a small body mounting plate on top of the beam. This is to reduce the body damage in certain conditions.

The servo saver is of the now standard two-part double V moulding with a strong spring holding the two parts as a friction joint. The servo saver mounting bolt clamps the chassis tweaker plate in place, thus enabling minor track side adjustment to be made. The steering linkages are of piano wire, bent and cut to size. The tracking is set by measuring a given distance between the servo saver and the steering drag links, and collars used to lock the setting. The front wheels have oilite bearings (ballraced also offered) and circlips hold the wheels on the stub axles.

The flywheel and clutch assembly is comprised of twin shoes fitted to roll pins on the flywheel with C springs used to hold the shoes closed in the idle position. The clutch bell has a roller bearing. The only problem in fitting the unit was that 1/8inch had to be cut off the crankshaft to enable the adapter nut to clamp the flywheel tightly.

Assembly plan on left. Below: Details of clutch and bellhousing arrangements.

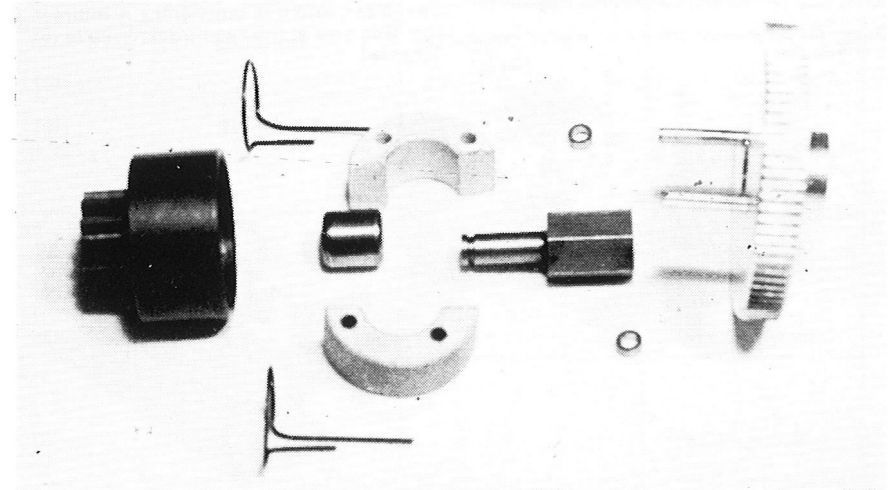

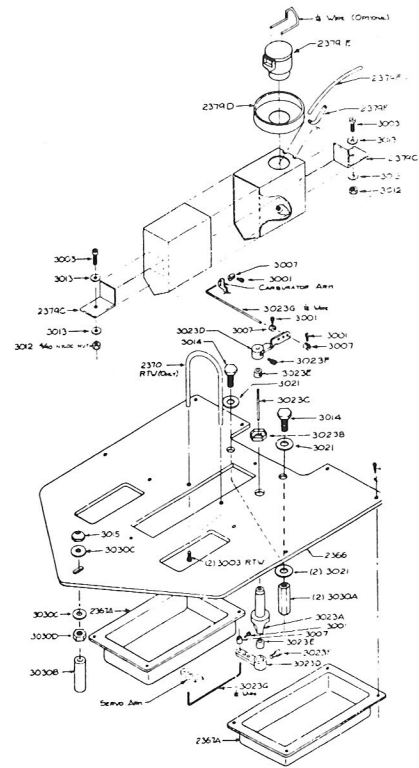

Above: Fuel tank construction and radio plate layout.

Below: Car put together before installation of engine and radio gear.

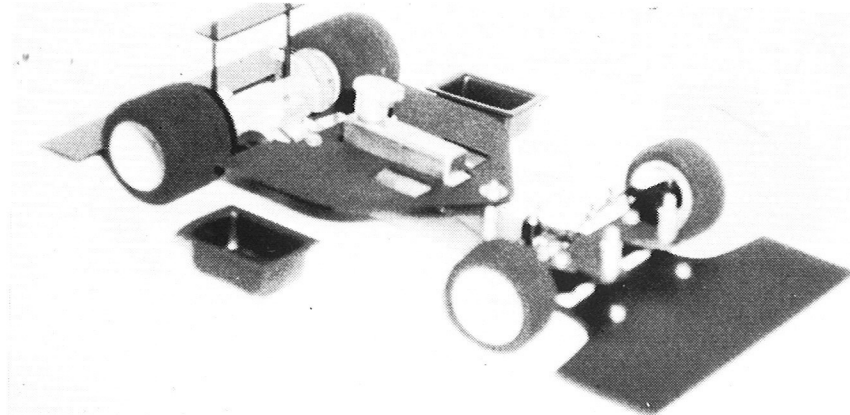

The fuel tank is a two piece tin job, has a bronze filter pick up and a flip top. Drilling and soldering up the tank is simple using an electric drill and a "cold iron" on the gas stove. The pick up unit later proved itself by scavenging every last drop of fuel from the tank.

The radio plate is pre-cut for the servos and fuel tank using the fitting screws provided. Two boxes are screwed to the underside of the radio plate to hold the Rx and battery. The Rx box 1/8 inch too tight for the Futaba Rx. However, by gently heating the box it was possible to re-profile it to accept the receiver!

The servo linkage wire is provided and requires bending to match the fullsize plans and fix in the respective positions with the collars. The radio plate has three fixing points, one front and two rear fit to the extension nuts of the chassis/engine pod bolts.

After fitting on a suitable body, a visit to the local track was anticipated. Unfortunately, inclement weather has meant that there has only been damp running to date. No problems have been experienced during these test runs and fair weather tests will be reported in due course.

MRP are currently producing their own differential unit and one should by now be available to fit to the car if desired.

To sum up, the car was easy to assemble, and all parts fitted without any reworking, so that the majority of the building was done on a coffee table in the comfort of my lounge using a few allen keys, a screwdriver and a pair of pliers. The initial reactions from tests to date are that the car will handle at least as well as my last year's car, and it is mechanically interesting. See you at the race-track: Vive la difference!

1980 CALENDAR 1/8 SCALE

	NATIONAL OPEN	EURO	INVITATION
April 5/6/7	Bournemouth	● Swiss G.P. Bruigg	
12/13 19/20 26/27	Bristol	● Dutch G.P. Utrecht	
May 3/4/5 10/11	Lilford	● Italian G.P. Florence	Tibshelf 6 hr.
17/18 24/25/26	Aberdeen Mendip		
May 31/ June 1 7/8		French G.P. Lyon ● WORLD CUP MONACO	Aldershot GP Bradford
14/15			
21/22 28/29	Wrexham		● Carnoux
July 5/6	● BRITISH G.P. TIBSHELF		
12/13		● German G.P. Weisbaden	
19/20 26/27	Aldershot West Burton		
Aug 2/3 9/10		● EURO CHAMPS GOTHENBURG	Bristol
16/17 23/24/25 30/31	BRITISH NATIONALS WOMBWELL		
Sept 6/7	Lampton	● Belgium G.P. Gent ● Austrian G.P. Innsbruck	
13/14			
20/21 27/28	Bradford		● Heemstede 3 hr. Holland Lyons 4 hr.
Oct 4/5			
12 18/19 26			Mendip 4 hr. Tibshelf Bristol G.P. Bradford 4 hr.
Nov 2 9 16 23			● EFRA A.G.M.

All dates confirmed but status of meeting subject to official approval from B.R.C.A. Standards Committee.



JIM DAVIS MODELS

145 NEWGATE LANE, MANSFIELD. NOTTS.
TEL. MANS. 36062



**WORKS REPLICA ASSOCIATED RC12E
1/12 SCALE ELECTRIC** - Available ready built.
All the latest from the factory incorporated in the car.
*Phone for details.

RADIO OUTFITS
Full range of all popular radio outfits, all at competitive prices. Please ring for full details.

1/8 ASSOCIATED TYRES		LEXAN BODIES	
2402 Ex stock	£4.20	Lotus 79	£7.50
2401 Ex stock	£4.20	Porsche 917/30KL	£13.84
835 Ex stock	£3.40	Elfin Can-AM	£13.84
832 Ex stock	£4.36	Porsche 935 Turbo	£13.84
3 DOT New rear tyres from Germany. High traction "Qualifying Tyres" Pr.	£5.95	Ligier Maserati	£13.84

SPECIALIST ITEMS	
A.M.P.S. Diff for P.B. (Mini)	£35.59
A.M.P.S. Diff Associated (mini)	£36.97
P.B. Differential (new)	£36.20
P.B. Air Filters (new)	£2.92
PB Slide Carburettor, complete with air filter, remote needle	£27.50
P.B. G.R.P. Chassis (new)	£8.52
A.M.P.S. Wheels Adaptors for P.B. to fit Thorp or Serpent Wheels	£10.11
A.M.P.S. Heavy Duty Servo Arms (pr.)	£1.12
Lexan Paint in Aerosols	£2.82
Lexan Paint (Supacar)	£1.00
Thorp Wheels (pr.)	£2.34
P.B. Ballraced Disc Caliper	£3.81
Ballraced Servo Tops for 17m	£4.79
J.D.M. Super Soft 1/12 Rear Tyres (pr.)	£1.75
J.D.M. Super Soft 1/12 Front Tyres (pr.)	£1.20

R/C CAR KITS	
P.B. International	£79.85
S.G. Futura	£76.70
Associated RC200	£127.75
Mardave	£25.29
Mardave Competition	£30.61
Serpent III	£80.06
100% P.B. and Associated spares and accessories stocked	

LATEST RELEASES	
Mardave Mk. 2 Beginners Special	£34.95
AMPS Micro Diff	£11.95
P.B.9. (complete with Diff.)	£127.27
S.G. Antares 1/12 (very good)	£42.95
P.B. 10 (Beginners Model)	£45.00

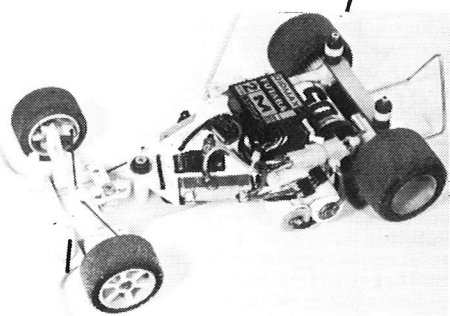

PARMA LEXAN BODIES 1/8	
Cheetah Sports	£13.84
Shadow Can-AM	£13.84
Lola T333 Can-AM	£13.84
Schee Can-AM	£13.84
B.M.W. 3.5 CSL	£13.84
Shafer Camero	£13.84
Toyota Silhouette	£13.84
Chevrolet Monza	£13.84

1/12 SCALE ELECTRICS	
Mardave Mk. 2	£42.95
Lectricar	£49.91
Bolink	£63.84
Associated RC 12E	£59.95
Tamiya Comp Special	£49.00
Push-on tyres and rims, fit Mardave and Schumacher wheels, used by Neil Francis	pr. £2.45

1/12 LEXAN BODIES	
McLaren M20	Pontiac Firebird
Porsche 30 KL	Pontiac Silverbird
Ferrari Boxer	Chevrolet Monza
Ferrari Daytona	Datsun 2602
Pantera	Greenwood Corvette
Kroll Can-Am	Volkswagen Scirocco
Ralt Can-Am	BMW 3201
Elfin Can-Am	BMW M1 GP 5
Porsche 917 K	Tovota Celica Turbo
Porsche 936	Porsche 935 Turbo
Carri Turbo	Ferrari 312 P
Lola T333	Ford Thunderbird
	Ligier Maserati

R/C CAR ENGINES			
Veco 19	£28.95	K & B 21	£46.95
Veco 21	£31.90	O.P. S 21	£48.95
S.T. X21 R.E.	£59.75	Irvine 20 Car	£42.06

BARCLAYCARD, ACCESS OR HOBBYCARD - 24 HOUR MAIL ORDER SERVICE

Hours 9.30 - 6 pm. Except Wed. closed all day

JIM DAVIS R/C RACING

Only 7 miles from M1 junction 27, 28 or 29

PONTIN'S

proudly present their fourth

National Model Makers FESTIVAL

incorporating

'The Golden Age of Steam'

'THE WORLD'S BIGGEST RESIDENTIAL FESTIVAL FOR MODEL ENTHUSIASTS'
at Brean Sands Holiday Village, Burnham-on-Sea.

TWO action-packed weeks for modellers and their families to fly, run, shunt, show or build their own models. Special courses for children and beginners, plus a whole range of interesting activities for the ladies.

Model Aircraft all types - R/C - Power - Free Flight - Slope Soaring - Combat - Gliders - Helicopters - Building - Instruction	Boats - Static Models - Yachting
● Fibre Glass Moulding	● Military Modelling & Wargaming
● On Site Tracks - Off Site Track Visits	● Special Optional Excursions to Steam Preservation Sites & Museums - Talks - Film Shows
● Fairground Models - Traction Engines - Model Engineer Workshop - Boiler Making - Welding - Brazing - Turning - Repair & Building Workshop	● Lectures by Leading Specialists in every field
● Model Cars - R/C - Stock-cars - Electric - R.T.P.	● Special Ladies Craft Section offering Instruction on a variety of Useful Crafts - Toy Making - Macramé - Confectionery - Brass Rubbing, etc.
● Model Scale Boats - Regattas - Straight Runners - Power	● Pastimes for Children of all ages.

All this plus dancing and cabaret every evening and all the usual Pontin Sporting and entertainment facilities: bars, games' rooms, supermarket, day nursery, heated indoor pool, etc.

A marvellous opportunity for modellers and their families to have a really economical holiday with like-minded enthusiasts from all over the country.

Tariff per week: Self-catering chalet with colour TV, private bathroom and toilet - up to 3 persons £53.00 + VAT.
Each additional person - £7.00 + VAT.

Brean Down (027 875) 203.

Saturday 27 September - Saturday, 4 October and/or Saturday 4 October - Saturday 11 October 1980.

PONTIN'S Holiday Village, Brean Sands, Burnham-on-Sea, Somerset TA8 2RJ.

Please send me details of the National Model Makers Festival.

Name

Address

..... Post Code.....

MCI

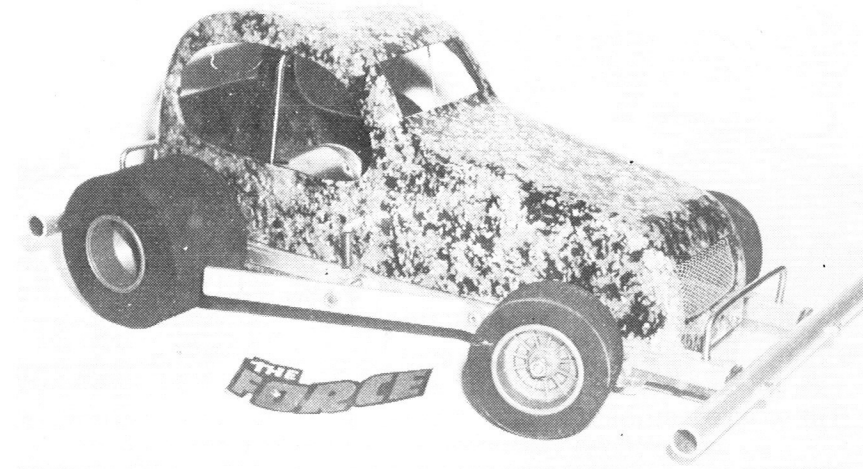

A GRP BODY FOR THE FORCE

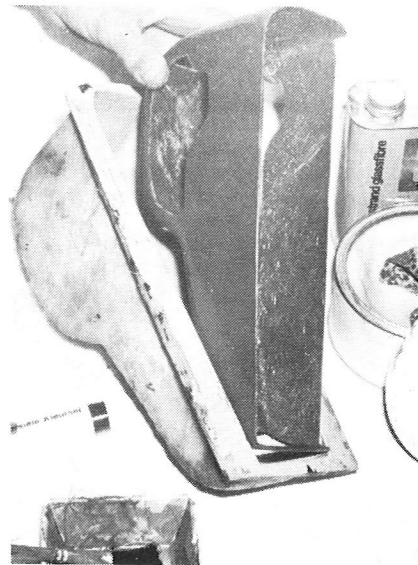

The most important thing in glass fibre/resin moulding is the mould, and it is very necessary to choose or adapt a design to suit this form of moulding and avoid any undercuts or fancy parts that will make release difficult.

Moulds can be made in many ways, either by carving and shaping a solid block of wood or plaster to your design or utilising a vacuum formed shape as a ready made female mould. If you use the wood or plaster method you will have to ensure your surface is very good as this will ultimately reflect upon your final mouldings, and you will have to lay up a sturdy layer of glass and resin onto your carving which when dry is released and used in its female form as your master mould.

Techniques of g.r.p. moulding vary but hand lay up is fairly simple and there are only a few important points to bear in mind. Firstly never forget to wax the master mould and treat it with a layer of PVA release agent before starting.

Polyester resin is the bonding agent and comes in a translucent form usually pinkish; this can be pigmented to a colour of your choice before use or if you intend spray painting the finished article this is not needed.

It is usual to use a first coating of gelcoat (a thicker type of resin) to form a surface that the glass will not surface through, but for a lighter moulding and for the sake of simplicity an initial coat of ordinary lay up resin will do the job.

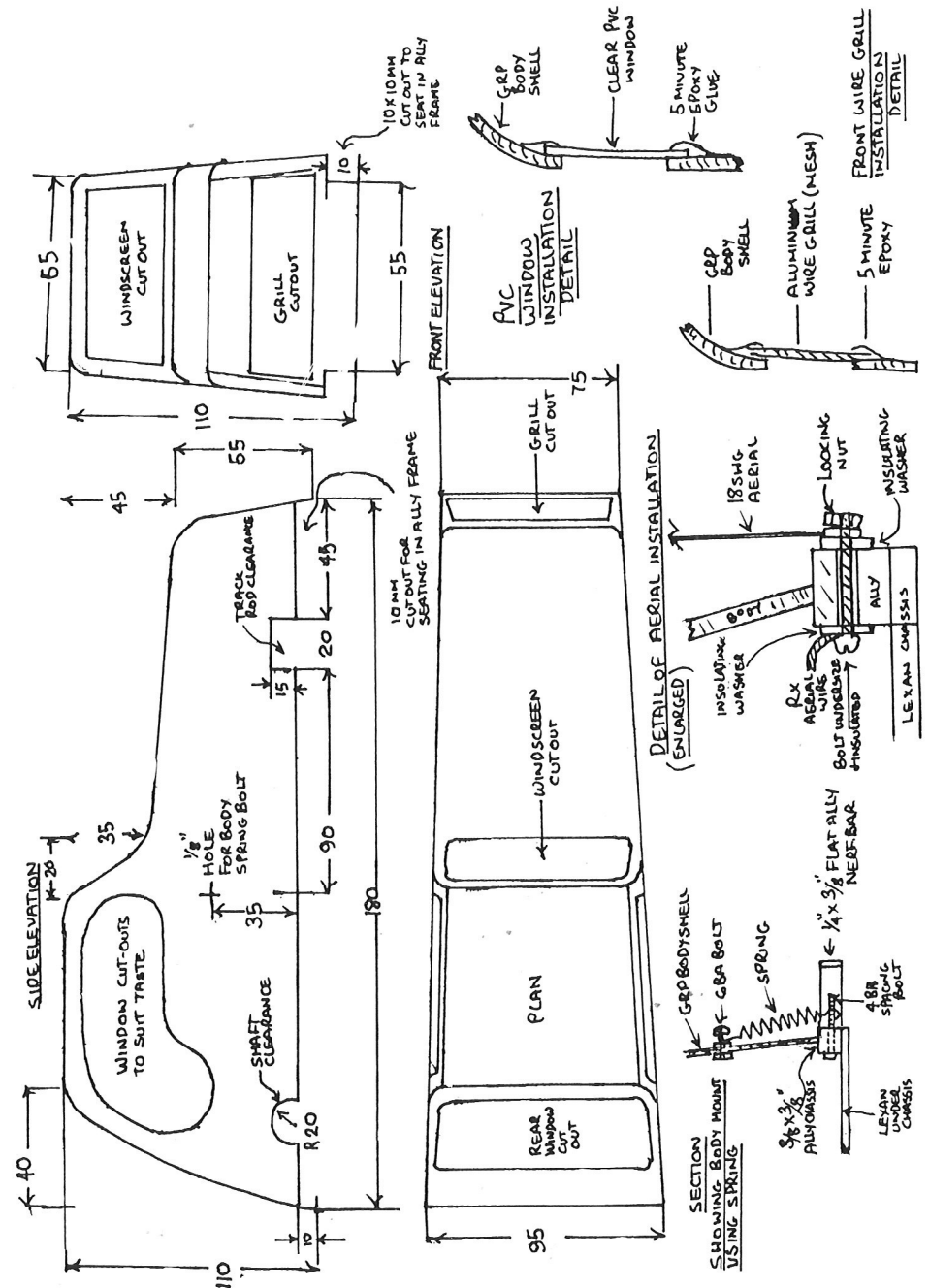

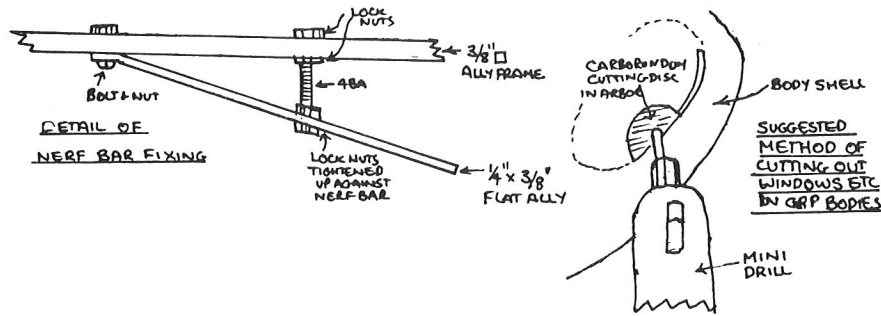

After this first layer has been allowed to cure to a tacky state you can then start laying up the glass fibre matting, ensuring that you have not catalysed too much resin than you can use easily within the pot life of the brand of resin that you have purchased.

Work the resin well into the glass fibre, ensuring that you leave no air bubbles trapped in the layers and also that you are keeping it at an even thickness all over. Having satisfied yourself that all air has been worked out and that the thickness is what you desire allow to cure. Overnight is best but this can be faster in a warm environment. Release from the mould is obtained by levering out the cured mold-

ing using the flange that you have allowed.

Now all that remains is to wash off the wax and PVA release agent, as this will stop any paint from adhering when it comes to painting the body, and cut out the windows and air vents. I find this job made much easier by using one of the mini type drills sold with an arbor holding a small cutting disc, but this can be completed by drilling holes and using a hacksaw blade in a pad saw handle.

Remember; follow the resin manufacturers' instructions in catalysing the resin and don't forget to apply the release agents before starting.

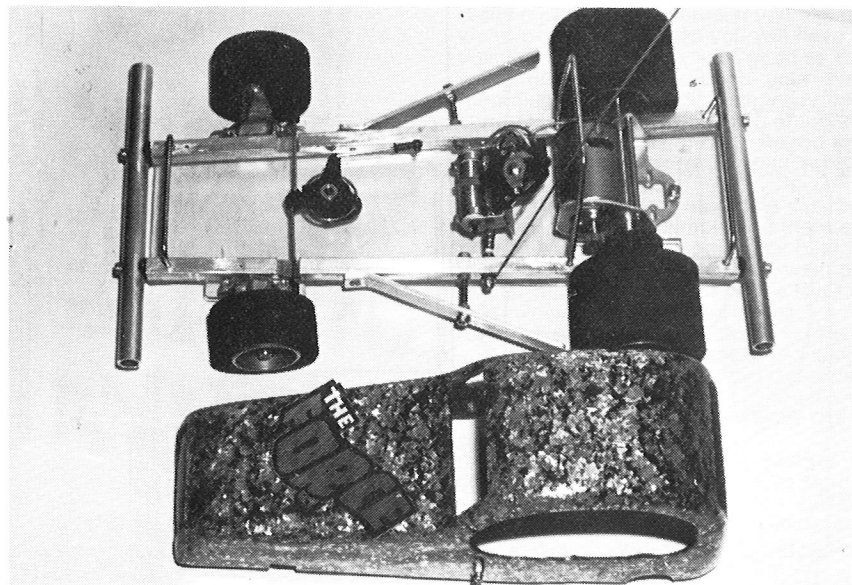

MATERIALS

500 gm pre-accelerated polyester resin and catalyst wood or plaster materials for body mold
resin pigment — colour to suit
silicone release wax
PVA release agent
epoxy glue
18 swg piano wire for aerial
6BA bolt tube and rubber washers

Sheets of clear acetate or PVC can be used for glazing the cut out windows using epoxy or cyanoacrylate to fix.

With experimentation you will find that one can embed numbers and glitter finishes in the first clear layer of gelcoat or resin and obtain some really fancy custom effects. Well attach your body to the force using the springs stretched from bolts into the body sides and hooking them onto the bolts spacing out the side nerf bars.

Radio installation is by the usual method— double sided servo tape— and it is advised to surround the receiver with some foam. The Force goes very well

MOULD DESIGN TO HAVE NO UNDERCUTS
MAKING RELEASE OF MOULDING DIFFICULT
OR IMPOSSIBLE.

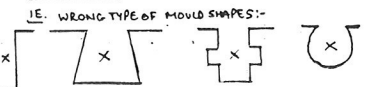

GRP MOULD-LAY UP

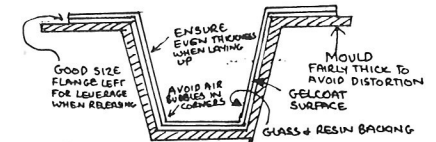

with 5 nicads and even better with 6. These should be soldered into a pack in the shape of a step so that they can be seated on the bar behind the motor and held in position with a sturdy rubber-band.

Let's hope you enjoy the Force as much as I have and good luck to your competitors.

RADIO STOCK CAR ASSOCIATION FIXTURE LIST 1980

April		
6th		
13th	Coventry	Open Event
20th		
27th	Leicester	Open Event (Series Championships Round 1)
May		
3rd		
10th	Primrose	Open Event (MAP) Racing Daily
4th	Chessington	Open Event (Crystal Palace Charity Sponsored Race)
5th	S.R.C.C.	Open Event (Rotary Club)
10/11th	Chessington	Open Event (Sandown Symposium)
11th	Keighley	Open Event
	Haywards Heath	Open Event
25th	Leicester	Open Event
	Pendle	Open Event
June		
1st	Keighley	Open Event
8th	Nottingham	Open Event
15th	S.R.C.C.	Open Event (Series Championships Round 2)
22nd	Nottingham	Open Event
	Pendle	Open Event
28th	S.R.C.C.	Open Event (Worthing Hospital Fete)
29th	Keighley	Open Event
29th	Keighley	Open Event
	S.R.C.C.	Open Event (British Gas)
July		
6th	Nottingham	Open Event
20th	Nottingham	Open Event
	Leicester	Open Event
27th	Keighley	Open Event (Series Championships Round 3)
	Chessington	Open Event (Wandsworth Show)

Note: There are meetings nearly every weekend for club members only who will be aware of their closed meetings. Meetings for August, September, October to follow.

hobby spot

516 Hagley Road West
Oldbury, Warley
Worcs. B68 0VZ.

TEL: 021-422 1000

1/12 ELECTRIC CAR SPECIALISTS

Phil Greeno "Gemini" 1/12 electric car kit now available (illustrated on cover) not the cheapest kit but could be the best excellent value at £79.00
All "Gemini" spares and parts also in stock.

NEW!

1/12 slip on tyres using the new Flexi Tube inserts will fit Mardave, Schumacher and Leatherland Hubs. Ready tried
Soft Rears only **£2.20** per pair

MOTORS

Mabuchi RS 54	£4.75	All Spares Stocked for
Mabuchi "Redspot"	£4.75	Mardave
Astro 05	£6.05	Lectricar
Astro 05 Red Label	£6.65	Phil Greeno Gemini
Igarashi "Porsche"	£9.75	Most Spares available for
Igarashi "Lotus"	£12.25	Cambria FWD and Associated

1/12 BODIES IN POLYCARBONATE AND ABS

Too many to mention. We got lots. Polycarbonate unpainted from **£4.95**.
Polycarbonate painted from **£6.95**. ABS from **£2.10**. Special Paint jobs to order.

SPECIAL ITEMS

Super 6-speed controller (Les Pipe)	£4.75	Ballraced Rear Axle Blocks (Mardave)	£3.95
Wiper Arm complete	65p	Ballraced Alloy Axle Blocks (Special)	£7.50
Parma Speed Resistor (Associated)	£5.23	Schumacher Differential all models	£6.95
Mardave Speed Controller	£3.50	Quick change Stub Axles suit Mardave	65p
Alpha Speed Controller (Recommended)	£3.95	Rear Wing Mounting set (Greeno)	£1.38
Associated Front End kit		Alloy Front Wheels Super suit Mardave	£3.50
Associated Front Wheels		AMPS Differential	£11.44
Front Wheel Ballraced (Associated) pr.	£3.85	Ni-Cad Rapid Charger 6 x 7.2v	£12.95
Lexan Chassis Plate 7 x 14	£2.50	Electronic Speed Controller with forward, reverse and braking	£34.00
Fibreglass Chassis Alpha	£3.95		
Ballraced Rear Axle Blocks Alpha	£4.60		

TYRES! TYRES! TYRES!

Raydio Soft, rear pair	£1.80
Raydio Soft, front pair	£1.20
Raydio Med Soft, rear pair	£1.80
Raydio Med Soft, front pair	£1.20
Raydio Hard, rear pair	£1.30
Mardave Std. rear pair	£1.45
Mardave Std. front pair	
Mardave Med Soft, rear pair	£1.70
Lectricar, rear pair	£1.35
Lectricar, front pair	85p
Palma Soft, rear pair	£2.20

RECHARGEABLE BATTERIES, etc.

AA Cells	£1.40	5 Cell Rechargeable	Special
Sub C Ni-Cads Soft	£1.95	packs, ideal for	6 and 7.2 volt Rapid Charger
Sub C Ni-Cads Std.	£1.90	Tamiya cars, etc.	with timer, 12 volt source
C Size Ni-Cads	£2.95	only £10.99	only £

Selected Soft Sub C Ni-Cads (120%) (Used by Team Hobby Spot) **£2.75** each
Most Cells also available in packs of 3 if required.

1/12 Schumacher Differentials to fit Mardave, Lectricar, Associated, tc. Always in stock PLUS all spares

KITS

Mardave Lola or Wolf Real Value	£42.50	Tamiya Cheetah	£52.00
Lectricar Porsche, BMW, Excellent	£49.95	Tamiya XR311	£46.50
Antares latest from SG Racing Cars	£42.50	Tamiya Porsche 936	£39.00
Cambria front wheel drive	£36.95	Tamiya 6 wheel tyres	£39.00
Graupner Porsche Can-AM FWD	£54.25	RC10 Race Car	£29.95

Plus the Phil Greeno "Gemini" kit, beautifully made and a winner at only £79.95

MAIL ORDER SPECIALISTS

Telephone 021-422 1000

Mastercard, Hobbycard

Access, Visa, H.P. Terms

Opening Hours: Monday-Friday 9.30-6.30. Wednesday CLOSED.

Please allow sufficient for P & P

All Prices correct at time of going to press but subject to alteration.

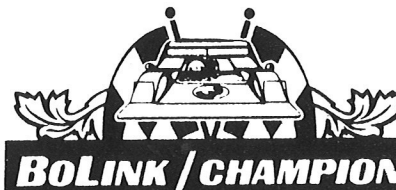

EXCITING NEW
PRODUCTS FROM THE
PERFORMANCE PEOPLE

420 HOSEA ROAD
LAWRENCEVILLE GA 30245
U.S.A.

The Fun Ones The DIGGERS - exciting off road racers

Tough Durable: Hours of Fun
Special off road tyres: Durable
Lexan Chassis with beefed up off
road suspension: Geared for off-
road racing and hill climbing: Extra
Ground Clearance for off road
operation: Powerful 05 motor: 6-cell
electric. Forward and Reverse
speeds: Available in 2 exciting styles
- Luv Truck/Baja'ed VW.



GROUP 12 -

a new concept in Club
Racing. Low cost racing where all
cars are equal. Spend your time on
the track racing - not in the pits
repairing and replacing costly parts.
Features: stock 05 motor: varnished
and balanced for longer life: durable
Lexan chassis: wide racing tyres: 1in
steel axle: shaker plate design: 2
body styles Porsche 935 and Elfin: 6-
cell fast charge batteries: D/C charge
cord.

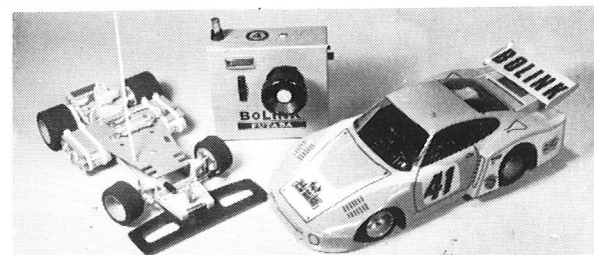

NEW BODIES MADE FROM TUFFAK

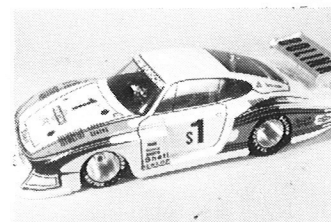

Porsche 935 - 78

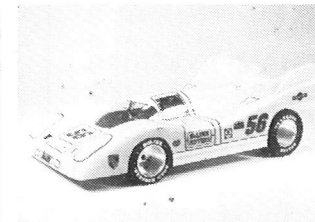

Porsche 917 - K

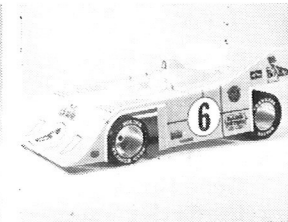

Elfin Can Am

Available in the U.K. thru'

TED LONGSHAW MODELS

80 PEPYS ROAD
LONDON S.E.14

MICRO-MOLD

STATION ROAD
EAST PRESTON
West Sussex BN16 3AG



Mini-Cooper

BO-LINK INDUSTRIES : WHERE QUALITY PRODUCTS ARE A WAY OF LIFE

ASSOCIATED RC12E 1/12 SCALE ELECTRIC

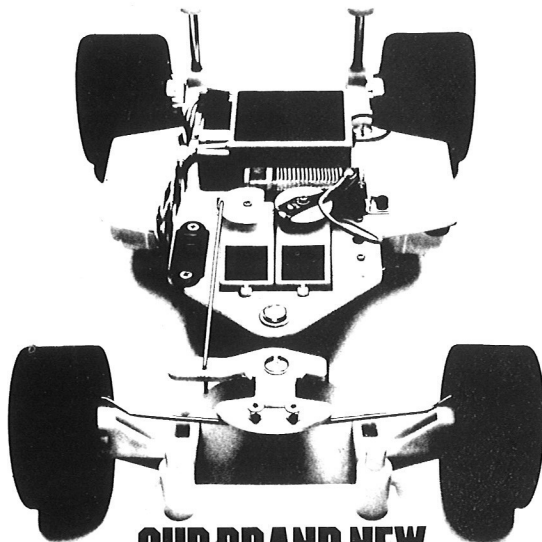

**OUR BRAND NEW
RC12E LOOKS LIKE A WINNER.**

IT SHOULD.

**WESTERN REGIONAL CHAMPIONSHIPS
THORP RACEWAY, ROAR SANCTIONED
134 ENTRIES**

Modified Class	Car	Motor
1 Gene Husting	RC12E	Reedy
2 Curtis Husting	RC12E	Reedy
3 Bill Jianas	RC12E	Reedy
4 Mike Rowland	RC12E	Reedy
5 Chuck August		
6 Bill Steele	RC12E	Reedy
7 Frank Killam		
8 Matt Azzara	RC12E	Reedy

Reedy Motors available from Associated
**RC12E wins all four 1/12 electric races at
1979 Roar Nationals**

ASSOCIATED, 1928 East Edinger, Santa Ana, CA. 92705, USA

ASSOCIATED NEW 1/8 RC300

1979 INTER-CONTINENTAL RACES

Most teams have one or two Super Drivers. We believe our cars handle so well it enables more drivers to become Super Drivers EASIER and QUICKER. JOIN THE SUPER DRIVERS.

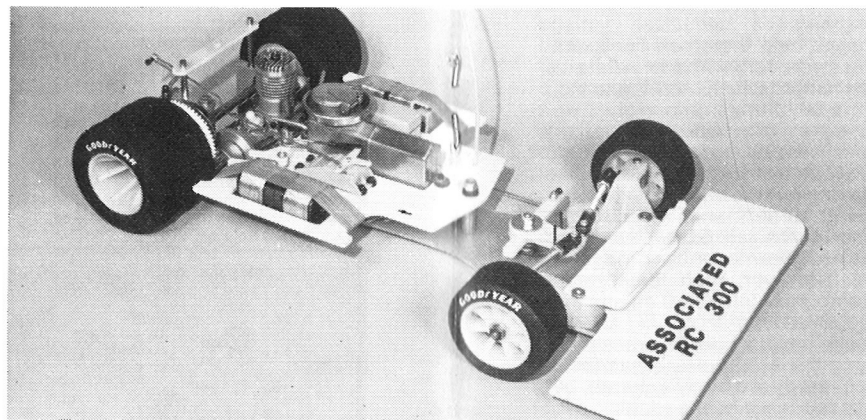

RC300



RICK DAVIS



DEBBIE PRESTON

At the WINTERNATIONALS race, BILL JIANAS qualified 1st with 32.8 laps, RICK DAVIS 2nd — 32.0 and JACK JACKOBS 3rd — 31.9. BILL JIANAS was in the lead at 65 laps when he lost a front tyre. At the WORLD'S CHAMPIONSHIPS, Ishihara from Japan qualified first, CURTIS HUSTING 2nd, JEFF ROLD 3rd, BILL JIANAS 5th and CHUCK PHELPS 6th. At 38 laps. CURTIS was leading with JIANAS 2nd and PHELPS 3rd. CURTIS'S engine locked up, JIANAS'S engine died twice and PHELPS ran out of fuel giving the lead to BOOTH. At WEISBADEN, CURTIS HUSTING was TOP QUALIFIER and the only car to turn 21 laps. JIANAS lowered the individual lap record to 14.0 seconds and DEBBIE PRESTON was TOP QUALIFIER from the Semi's.

WINTERNATIONALS ORLANDO, FLORIDA USA

1 Rick Davis	Associated	USA
2 Mike Rowland	Associated	USA
3 Gene Husting	Associated	USA
4 Phil Greeno	PB	England
5 Bill Jianas	Associated	USA
6 Roger Curtis	Associated	USA
7 Arturo Carbonell	Delta	USA
8 Phil Booth	PB	England
9 Keith Plested	PB	England
10 Jack Jacobs	Associated	USA

WORLD CHAMPIONSHIPS GENEVA, SWITZERLAND

1 Phil Booth	PB	England
2 Bill Jianas	Associated	USA
3 Chuck Phelps	Associated	USA
4 Fujio Sasuga	AAT	Japan
5 Naoki Ishihara	Road Ace	Japan
6 Rick Davis	Associated	USA
7 Jeff Rold	Associated	USA
8 Ronnie Ton	Serpent	Holland
9 Dave Martin	PB	England
10 Curtis Husting	Associated	USA

WIESBADEN GRAND PRIX WIESBADEN, GERMANY

1 Rick Davis	Associated	USA
2 Debbie Preston	Associated	England
3 Franz Groeschl	Scratch	Germany
4 Peter Bervoets	Serpent	Holland
5 Bob Errington	PB	England
6 Ronnie Ton	Serpent	Holland
7 Phil Greeno	PB	England
8 Curtis Husting	Associated	USA

Available from: **IRVINE ENGINES**

GETTING THE BEST OUT OF YOUR NICADS

THE NATURE OF NICADS

It is important to understand the characteristics of the battery pack in your car because how you use it will greatly affect both its performance and life. With proper care your pack will give top performance for many hundreds of cycles.

The battery supplied with your car is composed of "sub-C" size cells with a maximum rated capacity of 1.2 amp-hrs. This means that the cells will supply 1.2 amperes for one hour, or 0.6 amperes for two hours, etc. This capacity rating drops to about 1.0amp-hrs. at high drain rates. For instance at six amperes (a typical average current drain for an electric car) the cells would discharge in 1/6 of an hour or ten minutes. This charge capacity is the same regardless of the number of cells in the pack because the cells are connected in series and the same current passes through each one.

Nicads are very efficient and they give back almost as much charge as you put in, as long as you don't try to put more charge in than they will hold. If you start with a completely dead pack and charge at four amperes for 1/4 hour, you will have put a total of one amp-hr (4 x 1/4) into the cells. More than 95% of the charge would be recovered if the pack were then discharged at the one hour rate.

WHY YOU SHOULD NOT OVERCHARGE

There is no way you make a nicad cell accept more charge than it is designed to hold. This means that the charging efficiency begins to drop off as the cell approaches a fully charged condition; and the portion of charging current not being stored becomes heat and pressure. If charging continues after the cell is fully charged, all of the current is converted to heat and pressure — about 40 watts worth — or the equivalent of the heat produced by a medium sized soldering iron.

UNFRIENDLY HEAT AND PRESSURE

Either excessive heat or excessive pressure is harmful to the cells; and getting rid

ASSOCIATED ELECTRIC'S
GENE HUSTING GIVES
THIS GOOD ADVICE IN
HIS KIT INSTRUCTIONS.

of one doesn't help the other. For example, cooling the battery with a fan while it's being overcharged will do nothing to stop the pressure build-up.

Excessive pressure momentarily opens a safety vent in the cell and a small amount of electrolyte is lost in the process. One such occurrence is not harmful, but frequent venting will permanently reduce the performance of the cell. Excessively high temperature can permanently damage the separators. However, high temperature also has temporary (and bad) effects that will be explained later.

Nicad cells have a built-in process for recombining the accumulated gas (actually oxygen) produced by overcharge, but the process produces heat and takes a lot of time. If you overcharge your battery and it seems to take a long time to cool down, it's because this pressure reducing reaction is taking place. Once the gas is recombined the temperature drops.

A hot nicad pack cannot be fully charged. At 130 degrees F (a temperature uncomfortable to touch for more than a few seconds) the cells will only accept about 50% of a full charge. This doesn't mean that a fully charged battery will lose charge if it's heated; it just won't accept a new charge efficiently. For this reason it is always better to allow the battery to cool before charging. A fan is helpful to speed the cooling process.

EXCESSIVE DISCHARGE

When a nicad pack is deeply discharged it is inevitable that one cell will run out of charge before the rest. When this happens the remaining cells continue to supply current to the motor but this current passes through the dead cell and "overdischarges" it, or actually tries to charge it in the reverse direction. The cell won't accept a reverse charge and begins to evolve a gas (this time it's hydrogen). There is no chemical reaction to get rid of the hydrogen, so once it is formed it stays until the cell vents. Usually the same cell is reversed whenever the pack is overdischarged, and hydrogen pressure builds

each time until the cell vents. Repeated venting will eventually dissipate the cell's electrolyte.

CHARGERS

All fast-chargers and fast-charge cords do basically the same thing: supply a charging current of about 3 to 5 amperes. Where they differ is in frills and accessories. Some chargers have timers that offer a certain amount of protection against accidental overcharge. Some have ammeters and discharge circuits. Others are capable of charging either four or six cell packs. Features like fault detection, slow-charge, voltmeters, and constant-current are all convenient, but naturally the more features a charger has the more expensive it becomes. There are no chargers on the market right now that have all of these features; and above all, there is no charger that "knows" when to stop charging. The operator has to know that.

HOW TO TELL WHEN YOU'RE CHARGED

One of the problems with nicads is their inherent voltage stability; the voltage of a fully charged cell is not much different from one that's about dead. For that reason several indicators, along with some common sense, are needed in order to get the most out of your battery. The following is a list of indications you should use to detect full charge.

Temperature Method-

This only works if you start with a cool battery pack. As the pack charges, frequently check its temperature by feeling the cells directly (you'll need a hole in the battery cup). As soon as you notice an increase in temperature stop charging. If the cells become too hot on you are way overcharged. Let them cool.

Time Charge Method-

This only works if you have confidence in the timing accuracy of your charger. Many chargers on the market only approximate a constant charging current; they may vary from six amps when you first start charging all the way down to two amps if the nicad pack is nearly charged and the voltage of the charging source is low. If the charging current varies, it becomes difficult to estimate the average current. However, if your charger is reasonably dependable you can use the following method.

Cycle your pack several times using the "temperature method" above. After you run the car the last time let the pack cool.

Charge again using the temperature method but this time keep track of the time required to reach full charge. Once you have established the time you can use it as a setting for the timer on your charger. To be safe use a setting about a minute less than what you established. This method allows you to charge without constantly monitoring the battery temperature.

If you charge a battery that is still hot from running, reduce the time about 20%. Then, after the pack has cooled, finish charging the temperature method. The reason for this will be explained later.

Voltage Method-

As mentioned earlier, voltage is a poor indication of a cell's state of charge. The change in voltage from 10% charged to 100% charged is usually less than 0.1 volts per cell. In fact other things like the temperature, current drain, and "cell memory" have a greater effect on voltage than the state of charge does. However if current flow and temperature are held constant, it is possible to see the cell voltage gradually climb during the charging process. The absolute value of this voltage isn't much use, but how the voltage changes is an excellent indication. To use this method you will need a digital voltmeter or an expanded-scale voltmeter capable of resolving 0.01 volts on the 10 volt range.

Connect the voltmeter across the nicad pack, preferably right at the cell terminals, or if that's not possible, across the terminals of the throttle control resistor. Don't try to read the voltage at the output of the charger because you'll end up reading the voltage drop through all the connectors and cables between the charger and the nicad pack; and that can sometimes mask the effect you're looking for. You should start with a nicad pack that is less than 1/2 charged. Connect your charger and begin charging at four amps. If your charger is adjustable set the current now, but don't try to change it later. A constant current charger is preferable here, but if yours gradually drops off during the charge, that's okay; as long as it doesn't drop below three amps.

Watch the voltage as the pack charges. Notice that the voltage climbs rapidly at first, and then very slowly in the middle of the charging cycle. This voltage will most likely be in the range of 8 1/2 to 9 volts for a six cell pack. As the pack approaches full charge, the voltage will begin to climb more rapidly; and as it goes into overcharge the climb will slow down and stop. This is where you stop charging; at the point where the voltage stops climbing. If

you left the charger on, the voltage would begin to fall as the pack went deeply into overcharge and started to heat up. The maximum voltage reached will probably be in the nine to ten volt region; the actual value is unimportant. Do not try to use a conventional voltmeter. Even a good quality VOM with a large, taut-band, mirrored-scale meter movement is not adequate; by the time you could see that the voltage had stopped rising, it would be too late.

Slow Charge Method-

Slow or "over-night" charging is a method you are not likely to use often. However, it is a good way to equalize the cells in your pack, and to bring the pack to absolutely full charge.

The charging current must be between 0.05 and 0.12 amperes. Any less and the pack will never reach full charge; any more and the pack will overheat. The time required to reach full charge ranges from 15 to 40 hours depending on the current used. The charger can be left on for a much longer time without harming the cells, but the output voltage of the pack will be temporarily lowered by an extremely long overcharge. The voltage returns to normal after a discharge-charge cycle.

LAST WORDS ON CHARGING

Quite a few charging methods have been presented here in an attempt to satisfy the needs of everyone from the weekend hobbyist to the serious racer. Getting that last 5% of charge is the hard part, and obviously if you're just out driving for fun it isn't necessary to try for that last little bit all the time. Properly cared for, your packs will last for many hundreds - even thousands - of cycles. Pushing them into overcharge constantly will definitely reduce their life.

GETTING MAXIMUM VOLTAGE (POWER) TO THE MOTOR

The paragraphs that follow are really for the benefit of serious racers only, since they deal with factors that influence the voltage and available power of a nicad pack. We're talking about a different of maybe 15% at the most, so if you're just out having fun, don't worry about it.

The output voltage of a fully charged pack can vary considerably depending on the temperature and recent activity of the pack. These effects are listed below.

Hot Means Slow-

Again high temperature has its bad

effects, this time by lowering the output voltage under load. Less voltage means less speed. At 130 degrees F the voltage of a six cell pack can be almost a volt less than normal.

Too low a temperature is bad too. Near freezing the internal resistance of the cells goes up considerably; and high charging currents cannot be used without risk of damage.

Memory-

There are three "memory" effects that can affect the output voltage. One is caused by overcharge. The cells "remember" that they were overcharged and put out less voltage near the end of the discharge cycle. This is particularly noticeable if the pack is slow-charged for too long a time.

The second memory effect is caused by repeatedly not using up all of the battery's stored charge before recharging. The cells "remember" that they aren't fully used and let the voltage drop off to about one volt at the point where discharge usually stops. An example would be where you run a series of five minute heats, recharging between each heat, and then try to run an eight minute heat. The battery voltage will be low for the last three minutes of the race. The cure is to fully discharge the pack before recharging. "Full discharge" means the point where the first cell goes dead. Never discharge beyond that point.

The third memory effect is the "topping-up" effect of recent charging.

The cells remember that they were recently charged and will produce a little more voltage early in the discharge cycle. Racers take advantage of this by putting the last minute or two of charge into their pack just before the race starts.

SUMMARY

- Don't overcharge - use the "voltage method" of charging, if possible.
- Don't over-discharge.
- Keep your battery as close to room temperature as possible.
- Fully cycle your battery before a long race.
- "Top-up" just before the start of a race.

It is clear that these useful hints and tips are by no means generally known as Giles Jackson's Technical Comments on the Winter Nats makes clear. Follow them and you too (plus the right car & lightning reflexes) are on the way to victory.

RADIO CONTROL SPECIALIST AND SERVICE ENGINEERS Planes • Boats



HOBBIES

CENTRE LTD.
Tel. 0742-581197

148 London Road, Sheffield 2

Helicopters • Cars

Hours 9.30-5.30 Closed all day Thursday

Large stock of Radio Control Outfits, most popular makes now down in price!

NEW

Futaba 2L plus 2 Servos (Dry) £44.00
Futaba 2L with FD17M Servos £58.00

REDUCED

Sanwa Stack 2 plus 2 Servos (Dry) £38.75
S.H.C. Ni-Cads and Charger for above £24.80
MacGregor Digimac 2 plus 2 Servos (Dry) £49.00

MacGregor Digimac 2 Special Car Outfit with 2 Fast Servos, Ni-Cads and Charger £99.50

NEW

MacGregor JR Series FM-2, all Ni-Cad with 2-High Torque Servos £115.00

1/8 SCALE CAR KITS

PB9 International (Inc. Diff and BodysHELLS) £127.27
PB8 International (Inc. Diff) £95.30
PB7 International (Basic Kit) £70.40
PB6 International (2 BodysHELLS) £79.80

NEW

PB10 (Beginner's Kit) £45.00
Mardave Competition Kit, Ferrari or Turbo £29.80
Capri (F/G Chassis, new Clutch) £26.50
Mardave Stock-Car £26.50
Mardave Autocross £80.70
Serpent Mk II (F/Glass Chassis)

1/12 SCALE (ELECTRIC) CAR KITS

Mardave Mk II (6 Cell) Kit - Lola 294 Sports or Saudi Williams £42.95
Lectricar - McLaren, BMW or Porsche £49.98
Associated 12E (Inc. Motor, Ni-Cads, and Body) £59.95

Associated 12E Basic Kit £29.95
Cambria (Front Wheel Drive) - Saab or Lamb Countach £36.95 (Ni-Cads £16.00)

NEW

Lectricar - Stock-Car

ACCESSORIES 1/12 SCALE

Schumacher Diffs (Mardave, Lectricar, Assoc.) £6.90
Lectricar Motors (with Caps and Leads) £4.79
Lectricar Seven Speed Controller £5.44
Fast/Charge Leads (State No. of Cells) £3.42
S.H.C. 'One Shot' Automatic 12v Fast/Charger for 6-cell packs £17.50

Full range of Mardave, Lectricar, Cambria Spares, Tyres, BodysHELLS, etc.

CAR ENGINES

OPS 21 (Inc. Carhead and Carb) £48.95
K and B 21 (Stand. No Carb) £39.95
OS 21FSR (ABC) £51.80
Picco 21 (Stand. or Long Crankshaft) £84.95
Irvine 20 (Inc. Silencer) £41.95
Veco 21 £31.75
Veco 19 £27.95

Full Range Spares for all Motors

ACCESSORIES (1/8 SCALE)

Full range of PB International spares, send for Catalogue and Price List 30p (Inc. Post)
PB Slide Carb. Inc. Airfilter £27.50
Dave Preston Slide Carb £31.00
OPS Slide Carb £16.95
OPS Slide Carb, Air Filter £1.50
PB Differential £36.21
AMPS Mini-Diff. for PB Serpent, etc. £35.59
AMPS Monaco Diff. for PB Int. £57.50
AMPS Mini-Pipe (OPS or K and B) £13.90
Greeno Tuned Pipe £16.95
Greeno New GRP Narrow Chassis £8.50
Greeno New Power Pod £10.95
Greeno New Wide Radio Plate £6.95
High Speed Main Bearing, OPS, K and B, etc. £8.54
Sullivan Starter (with Car Rubber) £29.64

NEW

S.H.C. "TR 500", Charger - Automatic 12v - Radio Ni-Cads Fast-Charger - T.B.A.

Full Range Tyres always in Stock

UFFRA Special, Slix and Super, Associated 2402, Do-Nuts, Serpent Hi-Bites, etc.

Full Range of Lexan and ABS BodysHELLS by PB, Parma, etc.

Greeno Lexan Paint £1.00
S.H.C. Porta-Power - Rechargeable 2v Starter Battery with Ameter - suitable for all Glow-Plugs up to OPS 300 £16.50
S.H.C. Autoglow, 12v - 2v Reducer £14.84

FAST MAIL-ORDER. NO DEPOSIT CREDIT (FROM £65). ACCESS, BARCLAY-CARD, HOBBYCARD JUST PHONE IN YOUR No. FOR IMMEDIATE RETURN OF GOODS

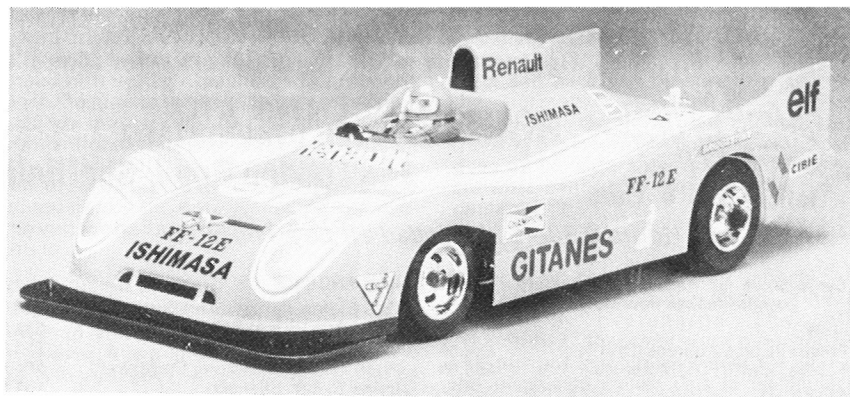

GRAUPNER FWD 1-12

Not very much has been seen competition-wise of the Graupner Front Wheel Drive electric car in the South though it has been going great guns in Scotland and the North as well as picking up a load of wins not only in Germany but also in France where it enjoys a strong following. I was reminded of my omission to try it out when I received the first racing accessory specifically designed for it in the shape of a rear block and axle from Walker Racing of West Lothian. So here it is up for appraisal.

The kit comes with choice of two Lexan bodies Porsche or Renault Mirage. I selected the latter since there are a lot of Porsches about and as a former Dauphine (I never rolled it!) and TL5 driver I have a slight sentimental attachment to the mar-

que. It could be described as "almost ready to run" since the difficult part has already been done, notably the assembly of the front wheel drive. This comprises a very stout injection cast alloy front axle bearing/engine bracket assembly which I would regard as virtually unbreakable (famous last words perhaps?)

A separate L-shaped casting holds the motor in place. A robust brass pinion gear is attached to motor via an Allen screw. Motor bracket allows some degree of adjustment so that the enthusiast can fit other gears if desired. Novel feature here is the presence of a differential with bevel gears and straight spur drive from the motor gear. This is in a hard plastic and not enclosed so that its condition is always visible. Drive to the road wheels follows

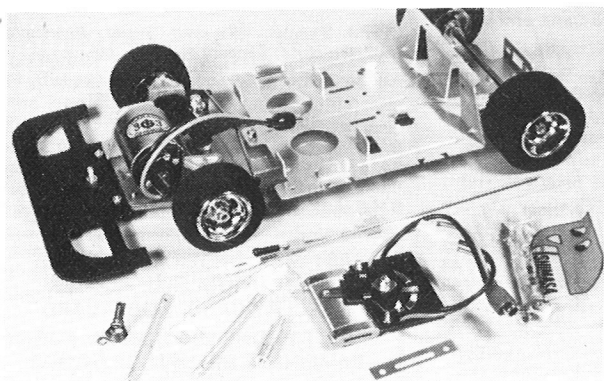

The car is French livery and decorated with the decals provided.

As the car comes out of the box with drive and motor ready assembled.

Close up of substantial castings for motor & steering parts with differential.

Front end on view, again showing strength of castings and Igarashi motor.

the usual slotted driving-dog principle. It is the smoothest sweetest running I have yet seen as already mounted. Servo saver and steering tie rods also fitted in place.

Motor provided is Igarashi which deserves a great deal more praise than it has enjoyed. Perhaps this car will help it towards a greater public approval – certainly for the longer race times of the future in standard trim. Power pod and rear axle assembly are joined by a GRP chassis comprised of a parallel strip approx 2-3/8 wide and 1-16in thick which gives a good degree of flexibility. This can be adjusted within limits by tightening the metal radio plate. Radio plate is designed to take a four or five cell nicad pack. If the more likely 6-cell is installed with pliers to obtain extra width.

Speed controller follows the usual wipe resistor style favoured by cars of Japanese origin, but has much more positive mounting than some I have seen. Servos mounted side by side bolt to an angle plate which in turn bolts on to the rear axle bracket. A smaller flat plate secures the forward ends of the servos and is supported by two metal tubes through which long bolts go attaching the set-up to the ratio plate. Slotted holes allow for servos of various sizes to be attached. Rear axle bracket has neat provision made for Rx on/off switch.

Suitable slots and bent up plates are provided for Rx and its battery which go each side of the two operating servos. I have put mine together initially as per instructions, but will be running it as well using the L & M electronic proportional

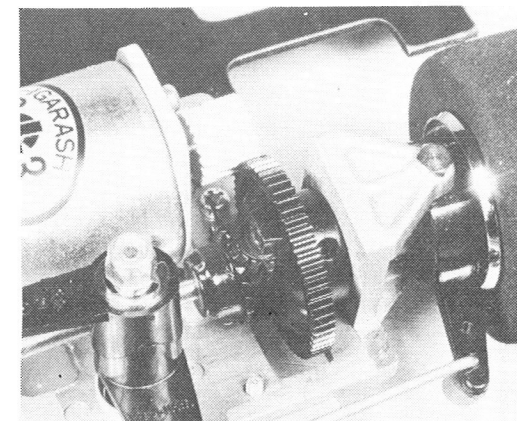

speed controller as supplied by Red Baron some time ago which will dispense with one servo and allow some latitude for trying out various weight distributions.

A stout front bumper is provided in the kit but the rear end with its fairly exposed speed controller resistor looks a bit naked so will fit a rear wire bumper which also serves as a useful pick up handle and can be fixed quite easily to the rear axle bracket.

Lexan body is very attractive and worth the trouble of making a nice paint job. The blue and white design on the box lid can hardly be bettered though many users may have the same bright idea so perhaps should be regetfully eschewed. A separate driver's head goes behind the built-in driver's helmeted figure and can be painted to match your favourite ace.

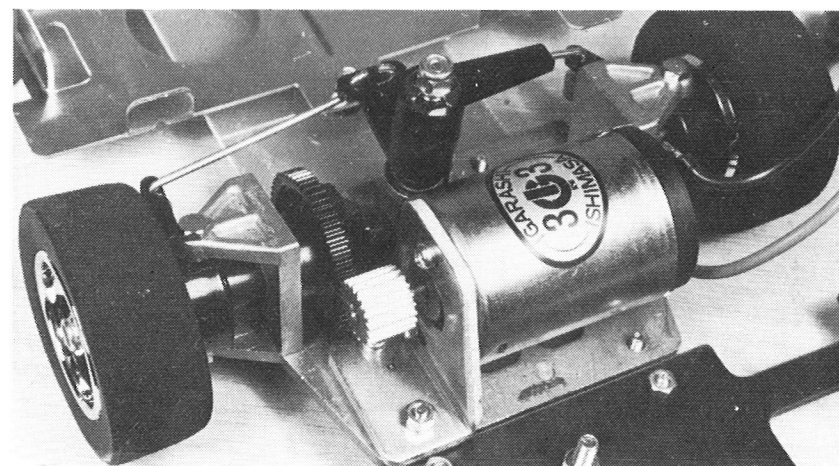

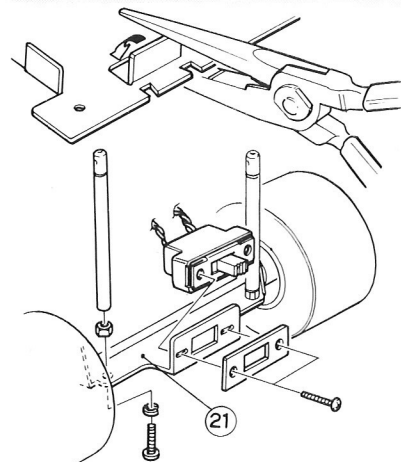
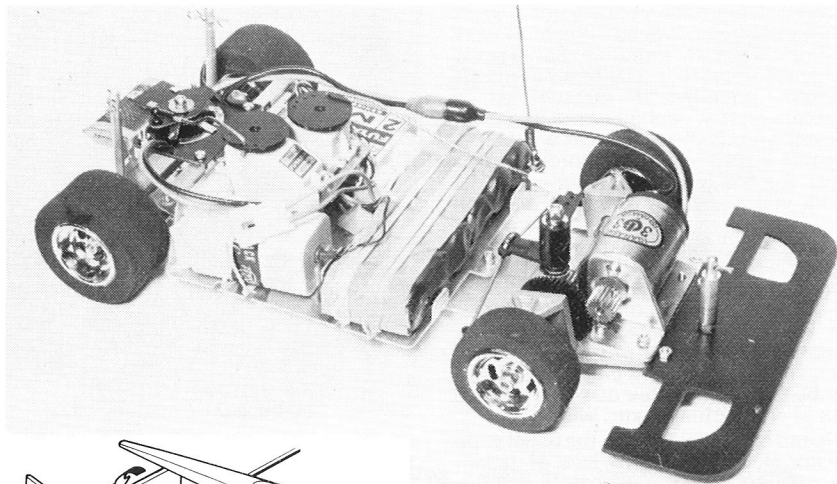

Above: Completely assembled car. Bending clip to make room for a 6-cell nicad pack. On/off switch placement at rear.

Below: Stouter rear end available from Walker Racing.

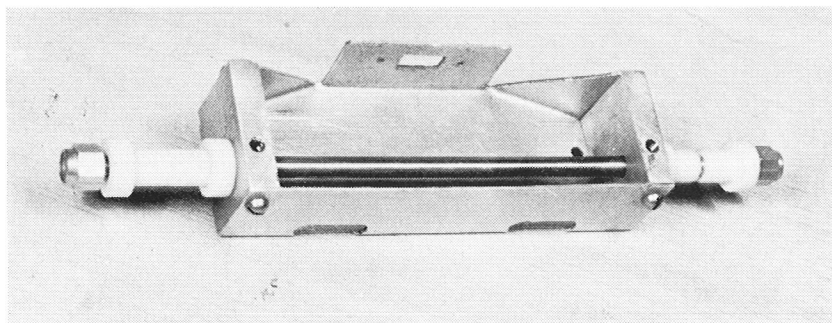

Instructions and line sketches in German are accompanied by a shorter version in English. Most of it is so straightforward that words are hardly needed, but do pay attention to the warning that positive motor connection low down and close to the power pod should have some insulation between it and the metal of the pod otherwise nasty things will happen should they touch as no fuse is provided. A charging lead is not supplied.

I also show the strengthened rear axle bracket and axle now being raced by Walker Racing under official title of "Team Graupner - Scotland". For serious races this is recommended as standard rear end can be bent in a crash (and who never has one?) Bearings are PTFE rod, almost frictionless, axle precision ground stainless steel. (Further details from Walker Racing, 84 Forrest Walk, Uphall, West Lothian EH52 5PW).

MICRO-MOLD

1/12TH SCALE R/C ELECTRIC CARS -

COMPLETE KITS PLUS A FULL RANGE OF PARTS FOR THE SPECIAL BUILDER

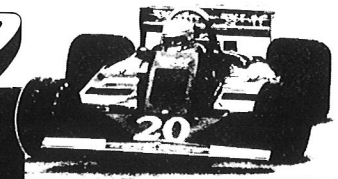

SERVO SAVER

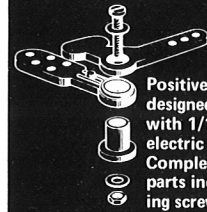

Positive, purpose designed for use with 1/12th scale electric R/C cars. Complete set of parts includes fixing screw.

V-N102 85p

WHEEL HUBS



V-EC35 Front Hubs - £1.69 pr.
1 1/4" diameter x 15/16" width
V-EC36 Rear Hubs - £1.87 pr.
1 1/4" diameter x 1 3/8" width

FRONT AXLE

V-EC15 £1.86



Beam axle assembly moulded in heavy duty nylon with king pins already installed.

In addition to those items featured above, MICRO-MOLD offers a complete range of parts for the 'special' builder. Included are Racing Slicks in a choice of widths and three different compounds, Body Shells, Body Clips, Motors, Chassis, Battery Packs, Speed Controllers - in fact everything required to complete your 1/12th scale R/C electric car!

FOR THE KIT BUILDER - OUR OWN MM 1/12TH SCALE CAR PLUS THE EXTENSIVE AMERICAN BOLINK 1/12TH RANGE.



The race-winning American car for the serious enthusiast. Well proven after many years of competition and development.

Complete BoLink kits include one-part moulded chassis with tough protective undertray: BoLink 05 motor with 6 cell nicad pack and wiper type speed controller. Hubs and tyres fitted and trued: Tough, light, clear Lexan body to withstand racing knocks.

Choice of body styles - £55.33

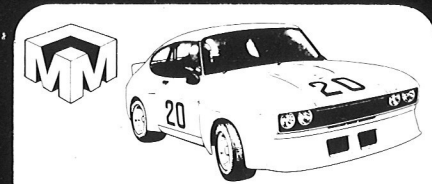

The MM electric R/C car has been designed with the beginner and expert in mind.

Construction is simple for the 'first-time' modeller with the aid of a well illustrated and comprehensive set of assembly instructions. The expert will find features such as adjustable wheelbase and alternative mid or rear engine mounting positions ideal for tuning the car to a particular circuit.

Choice of body styles - £51.52

Full BoLink and MM spares service

Available from your local MICRO-MOLD stockist

MICRO-MOLD
Station Road · East Preston
West Sussex · BN16 3AG

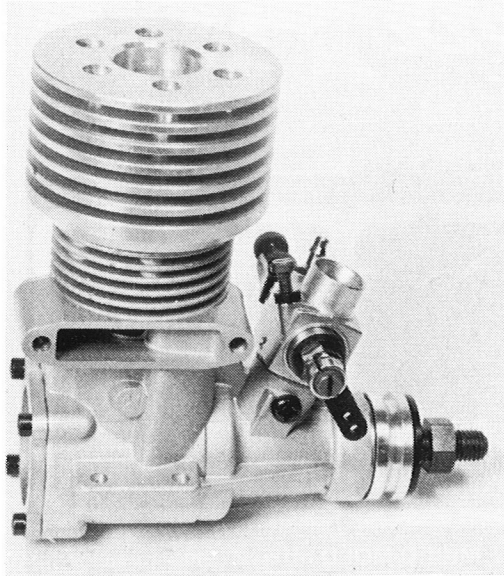

The small carb is one of the attractions of the OS Max 21 enabling extra long runs per tankful. A special flywheel assembly is required (PB Part No. 13/107) and a special exhaust manifold (PB Part No. 14/103).

Ever since its debut at the World Champs in Geneva last summer the OS Max 21 has been exciting interest in Europe. Stocks have arrived and should now be installed in a number of cars just waiting for the "off" signal. I was particularly pleased therefore to get a letter from

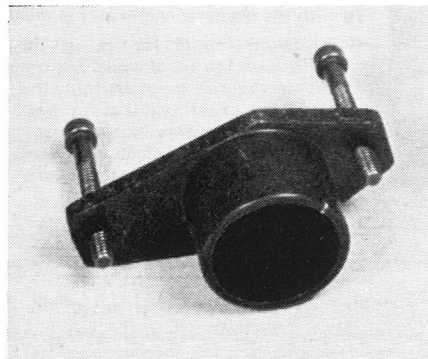

OS 21 MAX

Heinrich Cornelissen who is a committee member of the Killarney R.C. Car Club of Capetown who has two year's experience of the smaller O.S. engines including this latest development. Now over to Heinrich:

"According to your article on the World Championships (Part Two) in the latest issue of *Radio Control Model Cars*, everyone is very enthusiastic about the new O.S. 21 FSR-C ABC engine. It looks to me however, as if you are lacking information about the engine, especially information that is derived from test runs and practical tests. As I have been using O.S. engines in my cars for two years, including the new one, I think I can give you some more detailed information about the new O.S.

The engine is very well manufactured and is built very strongly. The machining is superb throughout, but the heatsink shows some magnificent engineering. To sum up the engineering of this engine I quote Gene Hastings: "O.S. has always been superior as far as machining is concerned."

The engine features the new O.S. Type 2C Automatic carburettor. It incorporates an automatic mixture control device which ensures that the engine receives a correctly balanced mixture of fuel and air at all throttle settings. The device progressively reduces the effective size of the fuel jet orifice as the throttle is closed, thereby preventing the engine from run-

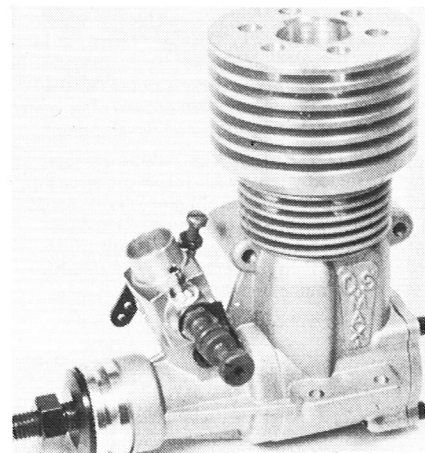

ning too rich at low speeds.

This also means that an airbleed is no longer required and with its elimination, maximum suction is maintained at the fuel jet at all times. This is a most important factor where manoeuvres have to be executed at low engine speeds and through wide variations of fuel level within the fuel tank. Once this carburettor has been correctly set, absolutely no setting is then required as it keeps its setting for a very long period.

Performance wise, the O.S. has absolutely shattering acceleration and torque available. It develops about .89 b.h.p. with 40% nitro. I would say that the small bore carburettor is probably the main reason for this excellent torque. The O.S. will definitely not rev as highly as the K & B, O.P.S., etc, but the difference in top speed will not even be noticeable. The O.S. can easily be modified to rev as highly as the opposing engines, by ment and improvement in the right areas, this engine can easily become standard equipment for all leading drivers.

GETTING IN LEAGUE

Success of the Southern League now off for its second season, and with a 1/12th electric section very much on the cards, has encouraged that excellent form of flattery imitation. Thanks to the sponsorship of Academy Park Lift Trucks a new mini-league has been formed under the title of "The Academy Championship" Four clubs are competing; Boston, Scunthorpe, Lilford and Newbridge. In passing this is very welcome news to learn that Newbridge is back on the active list, as I have been hearing sad tale of the circuit — first purpose built in England! — getting tatty and neglected since interest had moved away to other activities. So Viva! Newbridge.

Participating clubs will each promote two meetings to make a total of eight meetings. Organisation of the meetings is left to the individual clubs only proviso being that two classes will be run, Sports G.T. and F/1. It is hoped that organisers will run what is described as an "amateur final" — definition of amateur being left to the club's discretion. It will be an unlimited entry meeting in each case (subject to club's total capacity of course) with the best five competitors from each club score points towards the perpetual club shields and individual awards. Points go from 20 down to 1 with additional prizes. Awards have been

O.S. 21 MAX FSR-C ABC

Displacement: 3.463 c.c.
Bore: 16.6 mm
Stroke: 16.0 mm
Shaft Thread Size: 1-28 UNF
Bearings: 2 Steel caged ball journals.
Front Bearing: Shielded.
Front Journal: 9 mm
Main Journal: 12 mm
Crankpin Length: 5 mm
Crankshaft Length: 12 mm
Rotary Valve Opens BDC: 35 degrees
Rotary Valve Closes TDC: 59 deg.
Exhaust Period of Crank Angle: 156 deg.
Main Transfer Period: 128 deg.
Third Port Period: 118 deg.
Carburettor: O.S. Type 2C Automatic carb.
Scavenging System: Schnuerle
Type: ABC.

simply fitting a bigger bore carburettor. The fantastic acceleration however, is more important than top speed. Another aspect in which the O.S. is superior in, is that you can get up to 15 minutes on a tankful of fuel. This is more than double the usual time.

To sum up then; I think this engine is most certainly going to be the one to watch this season. With some develop-

made possible by a sponsorship donation of £250.

Last meeting of the season will be held at Lilford when the sponsors will make the presentations to the winners. This should be a medium skill series starting on 20th April at Newbridge. Drivers who have hesitated to join a club may well be encouraged by this series which provides racing at not too great a distance from each participating club. Interested parties should get in touch with Ted Booker, Kennels Bungalow, Barnwell Manor, Barnwell, Peterborough (Tel: Oundle 2910) who will provide more gen., and channel enquirers to their appropriate club.

The Midland Electric group have been running inter-club events for quite some time and even travelling down to London to take on Ally Pally, and it is clear that such fairly closely grouped club units can maintain a spice of variety to club racing, so that you know who is not going to be the evening's winner every time. Ever mounting cost of travel again is a factor which may tend to keep people from attempting very long journeys. The shorter trips also make single day out and back occasions more feasible. I can think of lots of reasons to wish these schemes the best of luck. Try them!

AVICRAFT LTD.

15 CHATTERTON ROAD, BROMLEY, KENT

01-460-0818
Open Mon, Tues,
Fri, Sat 10 till 6 pm
Late night
Thursday 9 pm
Closed Wednesday

TED'S SAND MASTER BUGGY -

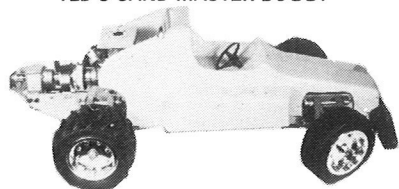

BRILLIANT ENGINEERING — will run on any-
thing — we've tried it!

THUNDER TIGER 20 Size BUGGY £99.50

All metal inc. ball links. Only plastic parts are
bodyshell and toothed belts to both rear
wheels.

FUTABA MEDALLION 3 £12 — or new "L" Series £22 — 2 Channel Combo

33m Servos £11. 17M Waterproof. Red or Black
£18 each.

METAL BOX NICAD Combo £70.50

These sets and these prices are unbeatable.
IN STOCK NOW MACGREGOR JR 2 Chan.
Special set at £115. FM Nicad

P.B. 8 and P.B. 9 — need we say more!

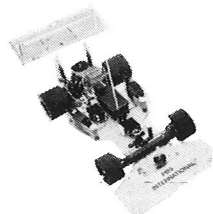

F.O.C. yes, really!
READY DRILLED
ENGINE BLOCKS TO
SUIT OPS, VECO or K.B.
Send 25p for price list and
leaflet.

MARDAVE STOCK CAR or AUTOCROSS £23.95



come here for
your kit and
engine and
accessories.
Silencer, etc.
starter wheels,
belts.

SPECTRON
complete kit
with electronic
speed
controller
£79.95
Speed
controller
only £29.95

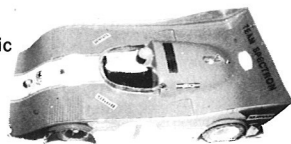

TAMIYA CHEETAH £52. XR 311 £46.50 post £1

Electric powered — ideal combination with
Futaba 3 channel. Medallion or 2 "L"

MARDAVE

Ferrari or Capri
in standard or
competition
versions.
All Mardave 1/8th
and 1/12 Electric
kits are fantastic
value for money



ENGINES:

K & B Car. Eng. inc. Sil. £46.95
VECO 19 Swivel end silencer £6.33
HB 21 P.D.P. RACE Car £41.95
OPS, ST., FUJI, as available.
FILTERS, PERRY CARBS and ADAPTORS to fit
60 CARB To 19 ENGS.

ELECK RIDER -

we have plenty in
stock ??? for how
long — HURRY —
£47.95

NICAD PACK £14.95,

Quick charger £12.
First and only radio-
controlled motorbike.
Steers and handles like the real thing! Banks to
45 degrees, speeds up to 20 mph with
proportional steering and electronic
proportional braking. Length 13 3/8 in.

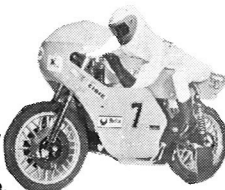

In conjunction with Ted Longshaw — DYNAGLOW, REVTEX, G-MAX FUEL STOCKED
Fast charge pencil and "C" Nicads stocked.

GB MODELS

R/C CAR DISTRIBUTORS

9 THORNBURY ROAD,
UPHILL,
WESTON-SUPER-MARE,
BS23 4YE.

Tel: 0934 — 26265
24 hour Answering Service
WHEN WE'RE IN BED!

THE SG 'ANTARES' IS HERE!

The long and eagerly awaited SG 'Antares' is now here! A stout GRP chassis with
moulded radio plate already cut out for servos and on/off switch in best SG tradition.
Shaped and lightened front bumper. Body posts, servo saver. Wiper type speed controller
of robust construction. Complete with standard motor and Lexan bodyshell.

£42.50 (excluding Nicads)

GB Models Own BODYSHELLS in Lexan or ABS : Real quality jobs — Ford Escort RS :
Mazda RX7 : Ligier Maserati : Renault Alpine : Ferrari 330P4 : Lola T70 : McClaren M8 :
Baby Bertha Firenza : Ligier Maserati : March BMW M.1.

Full Range of PB Serpent & SG Kits & Parts Ex-Stock

NEW Super Tigre X21 Rear Exhaust Engine **£64.95** complete or **£54.00** (less silencer and
manifold). New WEBRA R/C Car Engine.

FULL Range of S.G. FUTURA III Parts Ex Stock. SG 1/12 Car Coming Soon!

BO-LINK BLX 94 1/12th Car **£63.85**; BLX 144 **£60.65** (no speed control). These are ready built
cars with painted and trimmed Lexan bodies awaiting your radio and r'aring to win races.

TYRES from PB: RAYDIO: DELTA: UFRA: SG: 1/8th and 1/12th scale.

TYRES!!! Even softer than ever before. Soft Neoprene, rotary cut for a finer finish.

BODIES from PB: PARMA: BO-LINK: SG PLUS THORP: DELTA: McCOY, etc. GOODIES.

ELECTRIC MOTORS

- (1) Super Fast 1/12 Electric Standard Version (21,000 no load rpm)
- (2) Super Fade Deluxe (23,000 no 102d rpm)

£14.95
£17.95

LEXAN PAINTS AND ADHESIVES

PAINT FOR MODEL CARS Specially developed for use on the body shells of Model Racing Cars
in both 1/8th and 1/12th scales. Features: Wide Range of Standard colours.

10 standard colours red (light), red (dark), yellow, light green, dark green, tangerine, blue (dark),
blue (light), white, black. Metallics: silver, gold, bronze, blue, green.

Can be brushed or sprayed, excellent adhesion to Lexan and ABS. Does not embrittle Lexan.

All colours are intermixable. **£1.00 per 50ml tin.**

These paints have been produced for easy application on both ABS and Polycarbonate (Lexan)
body shells. It can be brushed straight from the can or by thinning up to 50% with a special
thinners (special thinners required). **£1.33 per 125ml tin.**

RUBBING PAD Aluminium Oxide impregnated plastic PAD. Ideal for flattening off any
model or paint surface prior to painting. Super fine or medium grades available (medium approx.
equivalent to 1200 grade "Wet or Dry" paper). **90p per pad.**

NO BLEED MASKING TAPE. A very special masking tape made from plastic. This tape can be
stretched to conform to double curvatures or to produce smooth curves. Produces a sharp paint
line. 10 metre rolls, **6mm wide 89p, 12mm wide 89p, 25mm wide £1.40.**

LEXAN ADHESIVE. Solvent bonds Lexan to Lexan permanently without making the Lexan
brittle. **93p per 30ml tin.**

Paint available in 50ml tins sufficient for approx. 2-3 body shells. Thinners in 125ml easy
pour tins

Prices correct at time of going to press.



SHOPPING AROUND AT NUREMBERG

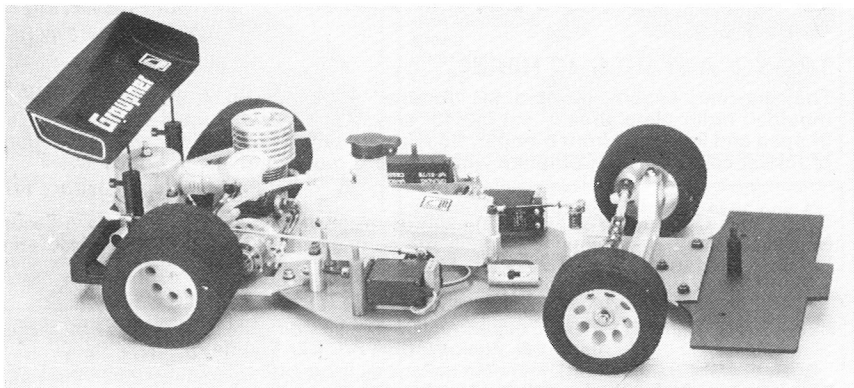

Latest Graupner i.c. car follows standard layout practice most elegantly.

Below: Serpent offerings: a new diff, designed by Peter Bervoets and Ronnie Ton's super silencer.

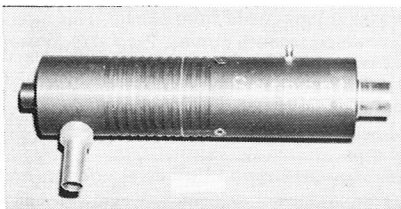
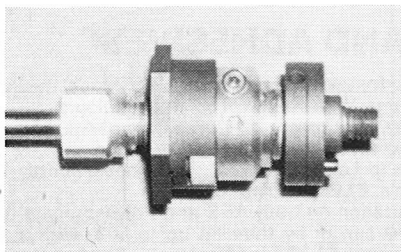

"Too many toys not enough kids" was the gloomy heading of one German newspaper report on this year's Toy Fair. With prices up, over 40% of materials being oil-based, and a million unemployed coming up, business was in general not too brisk. Our own little corner of r/c model cars provided some very hopeful rays of sunshine with Graupner turning wholeheartedly to embrace the car side of his business and Tamiya committed to providing cars capable of rough off-road operation. The specialist firms with less ambitious production runs in mind continued a quiet progress of improvement and development.

I was able to see the new Webra car engine for which a very bright future is promised. It will be imported in the U.K. (by Model Rectifier UK Ltd) without carb, and with some modifications to the specification which Webra are happy to do. It certainly looks right and in adding a further motor to the usable 1/8th scale range gives us a chance to be different. This with the OS21 now coming in well plus the OPS, STX21 and K & B, plus the old favourite Veco, still dear to many hearts and the more modest HB21 and Irvine provide a splendid selection to suit all degrees of skill and pocket.

This year PB Racing Products with their German distributors MacGregor had a

The eagerly awaited Webra car engine. To be imported without carb, and one or two other mods by Model Rectifier UK Ltd.

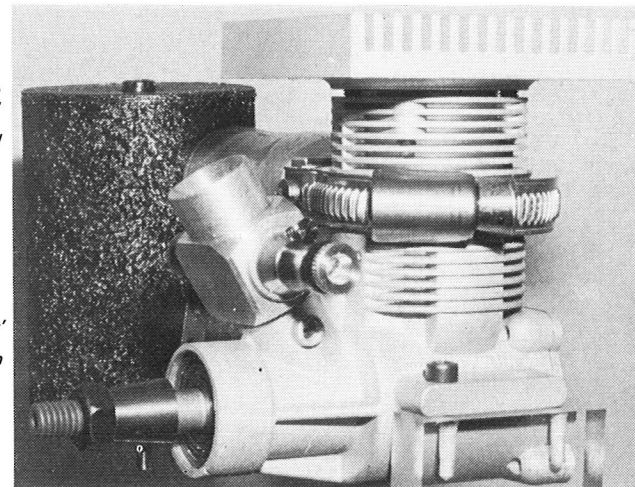

Bottom: PB Racing Products' bid for the starter kit market the PB6 to be better known as the Colt.

somewhat larger stand able to do justice to their various goodies. Keith having reached the pinnacle with the PB9 has gone sharply down market to provide a true "starter kit" – I will not call it a beginners' model! – under type number PB10 and happily titled "Colt." This replaces the PB Junior and sells hopefully at under £50, well under in fact. It is in the direct PB tradition with power pod, plain axle, nylon bearings, good quality alu. chassis, steering unit, plain bearings for wheels, simplified steering connections, servo mounts, ABS body, tyres, wheels, simple clutch, gears, radio plate. No silencer or tank.

Design is such that it can be up-graded bit by bit as the builder wishes to come to PB9 specification. It should be a winner all over Europe.

Up market has not been neglected. For PB9 disc brake is now a separate attachment not integral with diff. Metal attachment plate holding gear to diff in place of plastic; quickchange 3-pin gear fitting retained by wheel nut. Flywheel improved – smaller and lighter. Option of a larger rear wheel hub (2-1/8in?) to enable a thinner tyre to be fitted thus reducing bounce, though mix such that operating life not affected. (It will not be compatible with

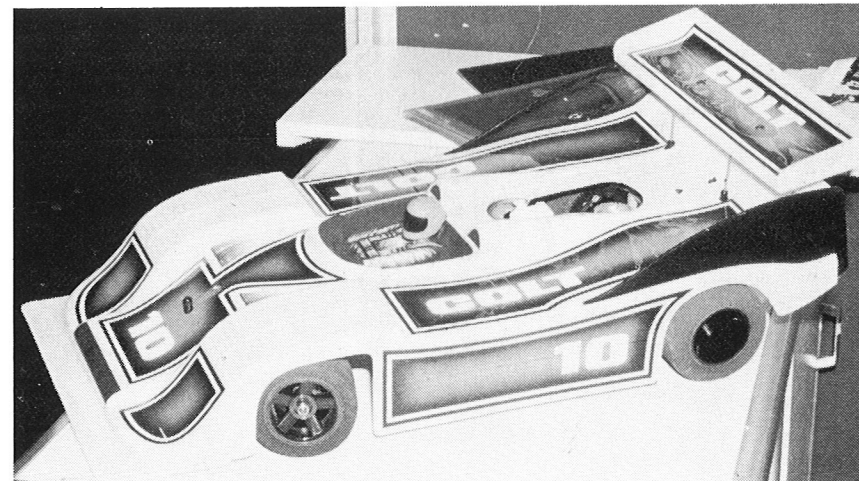

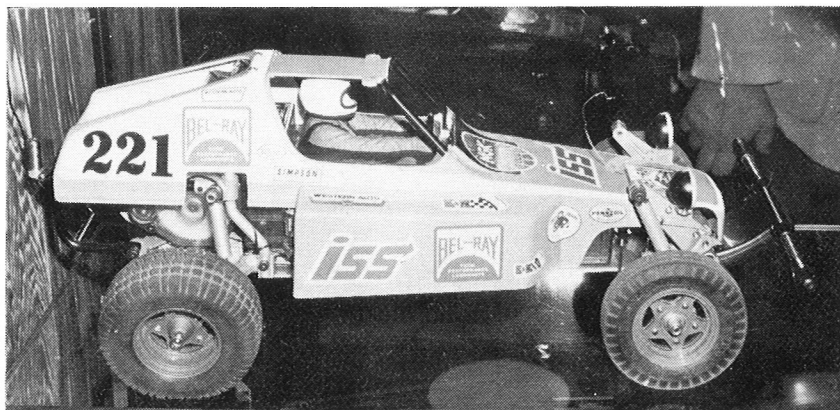

Tamiya's off-road car hydraulic springing to all four wheels and thoroughly stout construction all round.

Below: Lectricar stock car for 1/12th electric in vivid Hot Lips Mama paint trim — note the heart side window!

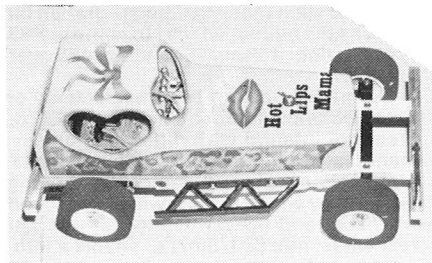

Latest Graupner importation trials motorbike complete with knobbles — available in electric power or with i.c., clever gearbox for same shown on right.

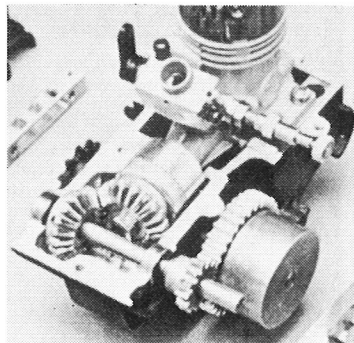

other wheels). Finally a new "tweak plate" is now available on the lines of that V-shaped fitting seen on some American cars last season which enable some adjustment to be made to a GRP chassis.

Until now the best silicone fuel tubing has been imported from the States. Keith has now had his own British version made up to the same high specification and is offering it in two qualities standard and de luxe. To be quite sure you get the right stuff the PB version is coloured blue.

MacGregors have gone for electric cars in a big way. Already a prototype proportional speed controller has been seen on test. The neat production model was on show, only final colour black, white, green red or what for the case to be decided. It has its own built-in reverse powered by

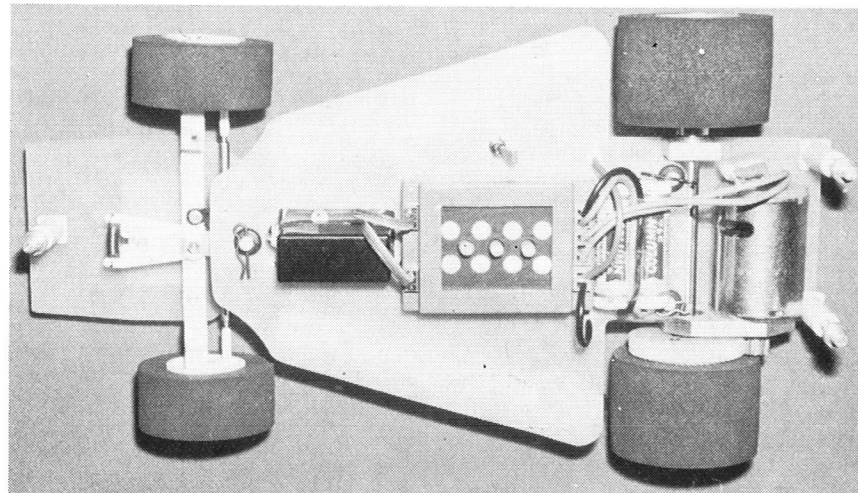

MacGregor proportional speed control with reverse (note the little batteries behind it) on their version of a Lectricar.

two mini-batteries that give enough movement to get a car out of trouble when blocked — definitely not for long rearward driving. Extremely neat and practical with plug and socket connections for easy removal. Price should be competitive. It is installed in a car with the smart "Swedish pattern" flat radio plate stiffener with slung ni-cads. Parts are definitely Lectricar but future whether as a Lectricar variant or as a MacGregor not yet decided. They are also showing an attractive off road buggy type of car which has distinctly Japanese origins under name of Trial 12 and sporting a typical MacGregor thistle emblem. I

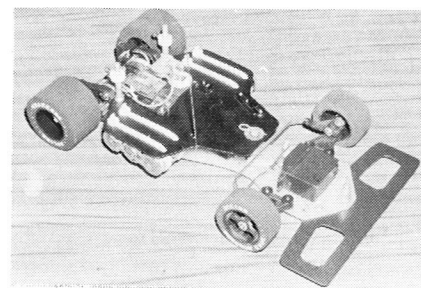

Bo-Link latest now with radio plate and general tidying up.

Graupner's Fiat X19 bodied car and their Mini-Cooper — sure to be a popular choice.



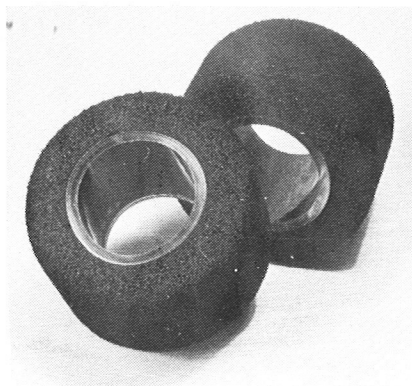
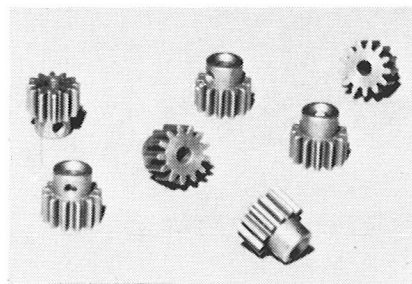
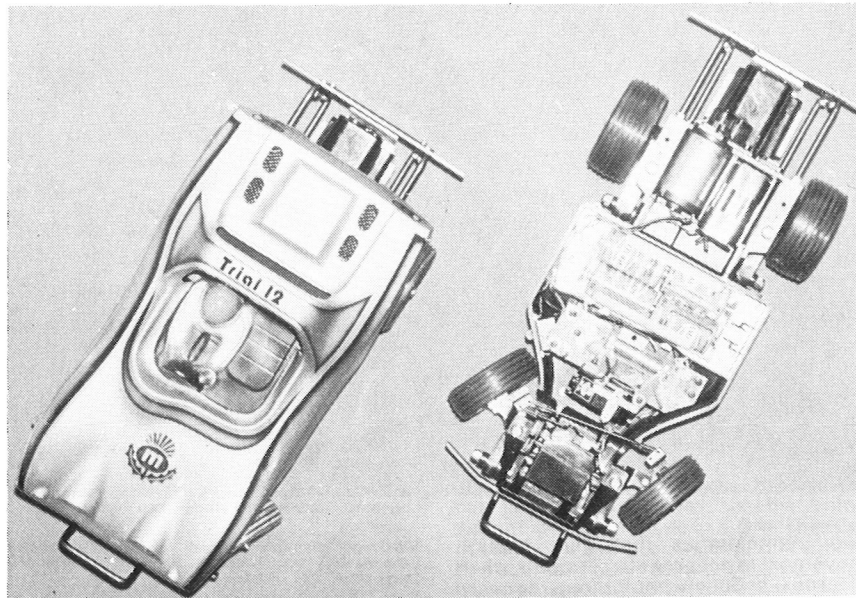

also liked the decor of their Lectricar stock car "Hot Lips Mama."

Dutch Serpent car, which had so successful a season last year, is now firmly under the control of Peter Bervoets and Ronny Ton, though still operating, I understand at the same factory. The partners have each contributed a new feature. Ronnie has polished up his silencer which was one of his last season "jollies" when he claimed it contained all kinds of secret weapons - it is neat and silent anyway whatever is inside (I still don't know). Peter has come up with his own version of a diff. This follows the hub pattern started by Cecil Schumacher for electrics and followed successfully by Delta in the States and Carlsson in Sweden, plus others which I have yet to see.

Bo-Link on a larger stand have been making some extensive changes with a view to taking a larger share of the growing European, indeed world, market. Options include the installation of a shaker plate (radio plate) with neater location of speed control servo - still the ceramic wound resistor type, forward placed steering servo, underslung nic-cads. Alternate

Another MacGregor newcomer their Trial 12 a buggy style with some interesting innovations. Plethora of gears 10-15 teeth from Parma Flexible wheelsleeves from Hobby Spot (not from Toy Fair).

layout to appeal to Euro tastes provides for nic-cads in line ahead (long sausage) each side. This version follows a Swedish design (he has a man from Sweden on the staff now) with a great race winning record in France, Switzerland and Sweden. Bob Rule now has his own limited slip diff., and is introducing a range of off road racers under the amusing name of "The Diggers." And do they dig! Bob has an exciting all action film strip to prove it. These have extra tough bodies, beefed up suspension and extra ground clearance.

Tamiya also have a splendid film to demonstrate the qualities of their off road units. These comprise a motorcycle/sidecar outfit in the modern "all body" idiom and a splendid off road autocross car sprung on all four wheels. This one should certainly be Tamiya's car of the year.

SG have gone for modest all round improvements with an interesting side mounted tubular silencer box not unlike the one Delta produced for Geneva. Another version of their electric car is also shown, though it may not be in the shops for some months, if Antares is anything to go by.

Big show must surely be Graupner. Almost the last of the big producers to accept the coming of r/cars genial proprietor Hans Graupner is now in what is the firm's Golden Jubilee Year giving it absolutely the lot! On the 1/8th scale i.c. side is the Expert Speed Car, a model which is in effect a development of Franz Groeschl's "own design" car which has been doing so well over the last two seasons as runner-up in 78 and 79 so often, 3rd at Wiesbaden and 1st at German Masters at Nuremberg in 79. We can safely say that in the right hands here is a winner. It enjoys a number of novelties as might be expected. Drive is now spur geared instead of with engine in line as the earlier car, and a dustbin type silencer fitted. Also new is a magnificent hub type diff with beautifully engineered steel bevel gears.

Invention is allowed free play with the new off road car Datsun Fairlady. This has stepped up gear, employs a novel exhaust system, knobby tyres and is hydraulic sprung on all four wheels. Power unit the HB21. Another novelty that will be embraced with joy is the introduction of a motocross motorcycle with nice trials type knobblies. This appears in two guises - the expected electric powered job using a Mabuchi RS540 and - surprise! surprise! - an i.c. powered version using an OS Max10 in line with a remarkable little bevel-gearbox. I would class this as the model of the show.

ON THE COVER . . .

"WINTER Nats" winner Phil Greeno had his winning Gemini painted up in production war paint to grace our cover - hence the layout. Beside it is MacGregor's new JR Series FM equipment selling competitively at £115 with Rx & two servos.

A number of new bodies, and a range of electric cars completes the r/c car picture for Graupner . . . but after that little m/cycle set up what more can one say?

Alpha Track Parts: Illustration on page 12 of Issue 14 purporting to show Mardave Mk. It was in fact Alan Blakeman's Alpha car. Apologies to all concerned.

A new slant on hub sleeves to allow quick tyre changes without removing wheels is provided by Hobby Spot of Warley. They are offering **flexible** - or should I say slightly stretchable? sleeves resembling outside fuel tube that will fit very nearly all of the popular wheels, making them almost universal. Tyres are glued on in the usual way and the sleeve stretched on to the hub. When on it grips extra tight and there is no risk of it slipping off. Indeed, it is quite hard work removing it again unless you know a trick or two. I found my old friend Vaseline did the job: just slip a thin blade from a palette knife for example between hub and sleeve and instil a little Vaseline and work it round - sleeves comes off easily. Wipe it off before the next use or you may loosen the tight grip. Price per pair as ready trued soft rears £2.20. Trade enquiries invited.

Graupner i.c. detail. Note exhaust manifold & silencer and geared drive.

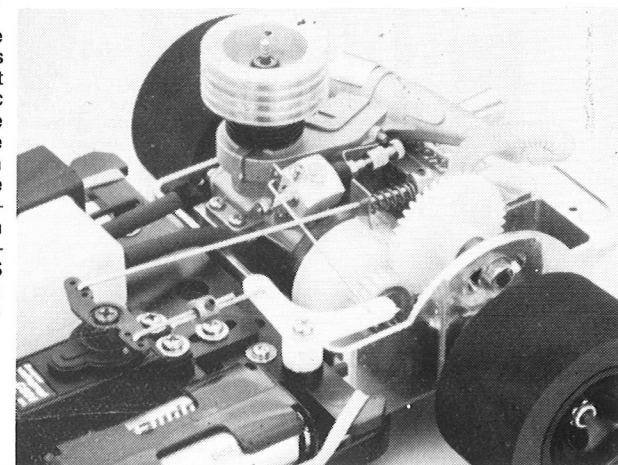

JOIN THE CAMBRIA TEAM

Choice of either Saab Turbo or Lamborghini Countach 1/12 scale electric racing car kits. Both these models use the same chassis with the Cambria Front Wheel Drive system for superior all round performance with none of the problems associated with rear wheel drive slip and spin. Kits contain all the parts required to assemble the models except for the 2-function radio equipment. Backed by a spare parts service second to none, full range of racing accessories, various tyre compounds and alternative body styles (Ferrari and Porsche shown).

NEW ADDITIONS TO OUR CAR ACCESSORIES

Cambria O.G. Differential Unit. Glass Fibre Chassis. 4S Speed Controller. Narrow Front Wheels and Tyres.

ASK YOUR MODEL SHOP FOR DETAILS OF THESE AND ALL OUR OTHER ACCESSORIES.

KIT PRICE including VAT.....£36.95

Nicad Battery Pack.....£16.00



Distributed in the U.K. by Cambria and Ripmax
All export enquiries to the manufacturers: Mid Wales Model Manufacturers Ltd.,
High Street, Llanidloes, Powys. SY 18 60A

PHIL GREENO MODELS LIMITED

9 Village Way East, Rayners Lane, Harrow, Middx. Tel. 01-8667770

SPECIAL ITEMS

*NEW Tuned Racing Silencer	£16.95
*NEW Lexan Paint 8 colours	£1.00
*NEW Metallics 5 colours	£1.10
*NEW Fluorescent 5 colours	£1.00
*NEW GRP NARROW Chassis	£8.50
*NEW GRP Standard Chassis	£9.05
*NEW GRP WIDE Radio Plate	£6.95
GPR Standard Plate	£3.14

Veco/McCoy parts always in stock

Brake Adjuster	£4.20
Roll Bar	£2.92
Alum. Body Post	£1.59
Comp. Clutch Nut (P.B.)	£2.75
Flip Top Tank	£14.37
Pumper 61 Carb.	£9.60
Perry Pumper 61 carb. (turned to 12mm)	£10.60

ACCESS! BARCLAYCARD! HOBBYCARD! H.P. TERMS PLUS FAST MAIL ORDER

S.G. Air Filter	£2.07
P.B. Air Filter	£2.92
Delta Fuel Filters	£1.59
Delta Output Arm	£1.00
Assoc. Fliptop Lid	£3.99
Field Charger	£8.46
Glowpack	£16.98
Machined Engine Blocks	pr. £2.07

ENGINES

O.P.S. 21 Car	£52.13
ST X21 Car	£51.40
K & B 21 R/C	£50.58
Veco 19 R/C	£29.23
New Veco-21 R/C	£31.89
Irvine 20 R/C	£38.28
ST X21 RE inc. manifold silencer, airfilter, heatsink	£64.96
ST X21 Re inc. heatsink and airfilter	£60.70
*NEW HB 21 PDP Car Engine	£40.89

Machined Rear Power Pod	£8.89
Machined aluminium Front Beam Mk 2, wider front track	£14.85
NEW Ballraced Disc Brake complete with fibre disc machined steel shoes	£15.92
NEW Ballraced Disc Brake complete with fibre disc machined steel shoes, assembly with Brake Adjuster	£19.11
Ditto DOUBLE ballraced	£20.18
A.M.P.S. Differential Unit with bearing blocks and disc unit to fit P.B. International	£57.45
Racing Special	£60.65
NEW Mini Diffs to fit PB Int. RC200, Serpent	from £35.67
PB Diff.	£36.21

PLUS A large stock of R.C. car spares always in stock including P.B. Associated, S.G., etc.

Plus parts available separately
1/12 Diffs in stock

Jerobee r/c electric	£59.58
Lectricar with prop. speed control	£47.78

All prices correct at time of going to press but subject to alteration.

Also large stock of BO-LINK, JOMAC, JEROBEE, ELECTRO CRAFT 1/12th ELECTRIC CAR KITS AND ACCESSORIES	
*NEW Full Range of TAMIYA KITS	
REWORKED MOTORS	
Inc. Pumper Carb.	
O.P.S. 21	£75.00
ST.X21	£75.00
K & B 21 ("McCoy-ed")	£75.00

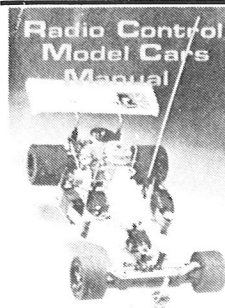

Radio Control Model Cars Manual

128-pages A/5 size (8 1/2 x 5 1/2 ins) Drawn on Card Cover with Photo-pics. Contains: Articles from the current year's *Radio Control Model Cars* covering such items as Tyres, numerous kit reviews and building guidance, World Champs in Geneva, Painting Car Bodies, Buggies, Scratch built cars. Plus articles from *Model Mechanics* on R/C Car Modelling for the newcomer, Stock Cars, Electrics. Digests from American model press on Hotting Up an Engine, Building Chicken Hopper Fuel Tanks. Plus for Electric Racers Highlights of famous *Ally Pally Newsletter* from Nick Adams. Starting a Club, International Racing Rules.

Price £3.25 (plus P & P 35p)

L-D EDITORIAL & TECHNICAL SERVICES LTD.
PO BOX 30 HEMEL HEMPSTEAD HP1 1NL

Or from good R/C Model Shops and Booksellers

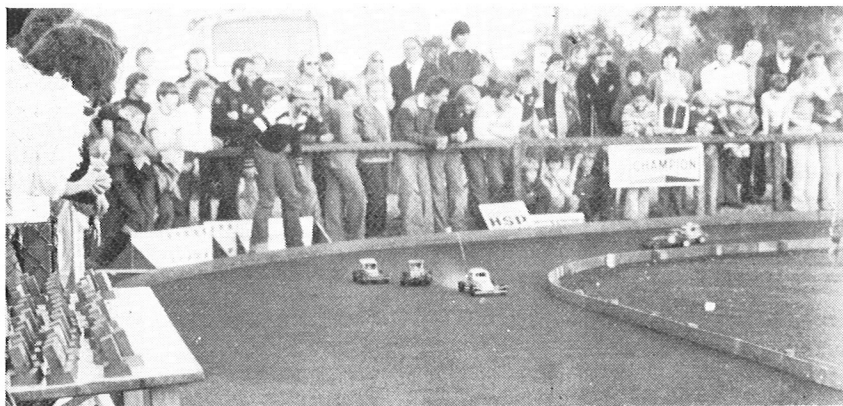

STOCKCAR ENGLAND CHAMPS

REPORT & PICTURES BY
JOHN PRICE & PHIL BURTON.

PHIL and I arrived at the circuit in Upton Snodsbury on Friday evening in time to help apply the last licks of paint to race control at this the first purpose built stockcar circuit. The Studley club have built in a very short space of time a track which appears to be based very closely on the Dutch circuit at Rosmalen. The track has raised outer and inner barriers with marshalling being done from the centre of the track, also an adequate fence around the track for crowd control. After the work was completed we all adjourned to the Coventry Arms for suitable refreshment.

Saturday morning looked far from promising, with a foggy start and showers predicted for the day. Practise started at 9.30 and it was soon apparent that the Studley lads had built a very fast track and being new was a little slippery due to loose particles on the surface. Drivers from around the country arrived during the day, the first being a team from Superstock Holland, whose early handling problems might have been due to the very liquid journey they had. The other Dutch Stockcar Racing Holland did not arrive until very late in the afternoon, but when they did it was in two coaches with 37 drivers plus mechanics and supporters. As the S.R.H. drivers had arrived so late all the others drivers agreed to clear the track to enable the Dutch to have the last of the

daylight for practice. It was as we expected, the Dutch being used to a similar sized track were going to be a force to be reckoned with.

After practice Paul Dudley had laid on a barbecue and disco for all competitors and friends, this was most successful with old acquaintances renewed and making many new friends. It also set the atmosphere for the whole weekend; one of friendly sporting racing.

Race Day.

Again a very dull start to the day weather wise, but as we have come to expect at these major international meetings, the sun broke through and provided the perfect weather for the first event organized by the S.M.R.A. It also gave drivers a whole new set of problems with different track conditions finding correct tyre compounds and worries about engines overheating etc.

Just prior to the first heat the cars were lined up to be judged for the "Concours" trophy and this was won by Coventry driver Derek Bird with an immaculately prepared car. The first heat got under way at 11-o'clock and while most drivers were treading very cautiously, S.R.H. drivers Piet Mans and Ernst Aalders put in a flying 32 and 33 laps respectively. Andy Briggs started extremely well and was giving Ernst a hard time and only a tangle on the top bend kept Andy from equalling Ernst's score. Brian Williams the "Puma" man returned a 31 lap score with a driving style that can only be described as smooth as silk.

Ron Bekking is lifted shoulder high.

Heat 2 saw Piet and Brian at the top again with some new faces challenging, Andre Venema, Bas Van Loopik, Tony Young, and Steve Waring all equalled on 31 laps. The tangles came thick and fast in this heat with all drivers suffering at some time, Tony drove a very good race with restored confidence after a disastrous first heat.

In heat 3 the pattern was firmly set with just one or two surprises, Dutch national champion Ron Bekking drove an inspired race cutting and weaving through the opposition to score a resounding 33 laps to equal Ernst Aalders with the highest lap score in the heats. Two other surprises were Jan V. D. Heyden who pulled out that extra zip to earn himself a place in the finals with a 32 lap score. The other surprise was Brian Williams who went out with a very low score of 18 laps, but with two good heats behind him was assured of a place in the finals.

The spectators were treated to one of the finest pieces of driving skill or luck? of the day by Joop Riphagen powering his car up the straight and flying through between two cars with little more than a centimetre clearance on each side, unfortunately his daring did not earn him a place in the finals.

After a short break while the positions were being calculated the finals were

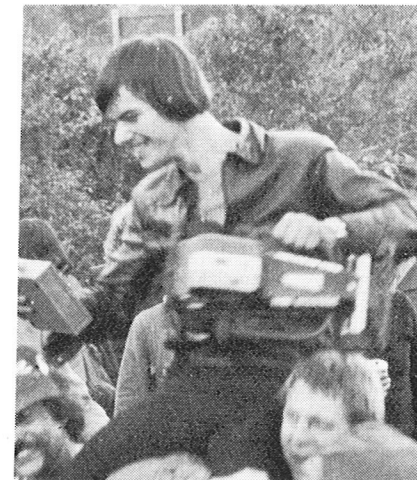

started, they differ slightly from what we are used to in having $\frac{1}{8}$, $\frac{1}{4}$, and $\frac{1}{2}$ finals before the grand final. The semi-finals were very hotly contested with all drivers on a fairly equal footing and lap scores were very close. The driving standards were very high with cars tightly bunched as they went round the track and placings for the final went to the drivers whose nerves could stand the immense pressure without making that one mistake from which at this level of competition there is no recovery.

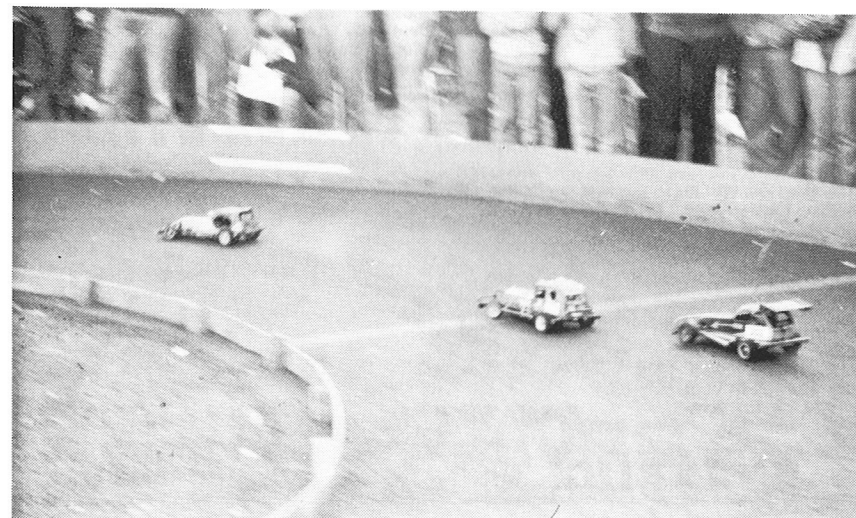



The finalists: five from Holland and a sole British representative.

The scene for the finals in the rapidly fading light was one of feverish activity, mechanics working on cars in the centre of the track whilst drivers stood on the rostrum the tension showing clearly in their faces. As the seconds ticked by Frits Aalders took his place in the centre of the track to start the race, and when he dropped his arm 6 cars, engines screaming, snaked away with tyres scrabbling for traction. After the first few laps all drivers had settled down and the cars were going round as if on rails, each driver pushing his car to the limit and waiting for his opponents to make a mistake. Brian Williams had recovered his old form after that devastating third heat and was driving a smooth pattern pressuring Ron Bekking but Ron would not rise to the bait. Current world champion Ernst Aalders suffered badly perhaps trying too hard and a

flame-out destroyed any chances he might have had, the flying Dutchman Piet Mans could not take off when it really counted.

The enthusiasm shown by the spectators was reminiscent of a Wembley cup final with people pouring onto the track and Ron being carried round at shoulder height through the crowd. I think that everyone who attended that meeting had a really good time and we are certainly looking forward to next year.

Results

- 1 Ron Bekking H 35 laps.
- 2 Brian Williams GB 32 laps.
- 3 Win Verhallen H 32 laps.
- 4 Piet Mans H 28.
- 5 Peter Singels H27.
- 6 Ernst Aalders H 17.

All H finalists from Stockcar Holland club.

Concours d'Elegance: Derek Bird Coventry S.C.C.

Best Lady Driver Mariette Vorstenbosch SRH. Most Laps in a Heat, Ernst Aalders & Ron Bekking 33.

2 NEW 1/12 CARS FROM

PARMA TIGER ... if you're racing to win, Parma now has what you have been waiting for. See it at your favourite hobby shop.

GROUP 12 ... A Class of racing that will never be obsolete. Start a series in your club now. Ask us for complete details.

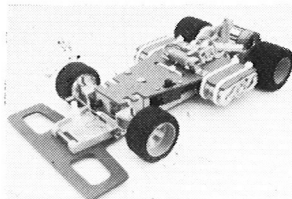

PARMA TIGER RALT

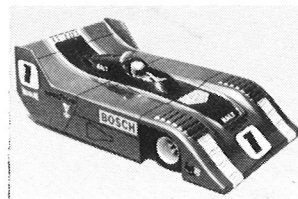

GROUP 12 CHASSIS

parma

13927 PROGRESS PARKWAY
NORTH ROYALTON, OHIO 44133, USA

parma
INTERNATIONAL INC.

Cecil Schumacher
'Rudge'
Harlestone Road
Church Brampton
NORTHAMPTON

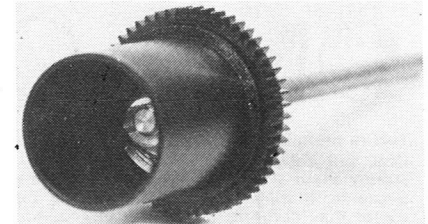
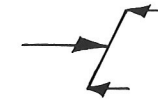

THE SCHUMACHER DIFFERENTIAL

With adjustable limited slip feature for 1/12 electric cars in black glass filled Nylon. 3in. Dia. 55 Ton Axle fits Mardave Bo-Link Jerobee Lectricar Associated Spectron, etc. 46, 48, 50, 52, 53, 54, 55 Tooth gears available. State car model and tooth no. reqd. **£6.90**

Or from your Model Shop

NEW : QUICK CHANGE TYRES

Indoor softs glued and ground true on rigid sleeves. Simple push fit onto our wheels. Guaranteed secure. As used by Neal Francis - British National 1/12 Electric Champion at Bradford and Exeter **£2.95** per pair
Cash plus 30p post & packing with each order.

Trade Enquiries Welcome.

FIXED WHEEL

to match with grub screws **80p** each

NEW FRONT WHEELS

Black glass filled Nylon for Mardave and Associated (state which) **45p** each

NEW 9, 10 & 11 TOOTH MOTOR PINIONS

Precision cut teeth with grub screw **£1.55** each

INJECTION MOULDING

Of small and medium quantities, including tooling, design and manufacture.

Callers by Appointment only

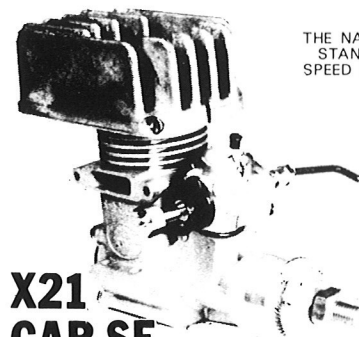

THE NAME THAT
STANDS FOR
SPEED & POWER

SUPER Tigre

X21
CAR SE
£40.99 complete with heatsink

SUPER TIGRE ENGINES are distributed by Micro-Mold & Tigre Engines.

Since its arrival last year the Super Tigre X21 has been the pacesetter for other manufacturers to follow. A rugged construction able to cope with the arduous conditions of competitive car racing. Just compare the specification with the opposition. An ABC piston assembly with light-weight piston, bronze bushed big end conrod, heavy duty 12mm dia. crankshaft running in double ball bearings, specially diecast crankcase not a conversion from aircraft motor, large bore carburettor with the superb idling of all MAG series carburettors, deep finned heat sink, squish band head. BHP .75 at 25,000 rpm, weight 9 1/4 oz. Used by most of Europe's leading drivers.

Race-proven to be one of the most reliable motors produced so far. It's the motor that finishes that counts. The long life of all Super Tigres together with easy availability of any spare part for that eventual day when its run "over the hill" makes this motor the popular choice. No Labour Charges on ST repairs: you only pay for parts and postage.

Don't forget TALISMAN 2-channel FM Systems are Britain's Best Buy for the serious car enthusiast. SAE will provide details.

SUPER TIGRE MOTORS ARE AVAILABLE FROM THE VERY BEST MODEL SHOPS

TIGRE ENGINES

Visitors by Appointment
S.A.E. with enquiries please

97 Tudor Avenue, Watford, Herts. Phone Watford 42859

ONE~O~ONE r/c

You've probably never heard the name of One-O-One, but thousands of slot racers have. We supply them with the best parts and services available, if they want a race winning car or motor they come to us, our frames, parts, and motors have helped our customers win no less than 2 European and several British National Championships.

Now we can offer the same services and specialist parts to the R/C racer. We have the usual parts by Associated, Parma, Bolink, etc. plus some unusual items from Mura, Trinity and Out-I-Sight.

Services include com trueing, magnet zapping, body spraying and much more.

For your free copy of our comprehensive list just send a 10p stamp now to

ONE-O-ONE R/C

52 Hawbeck Road, Parkwood,
Rainham, Kent, ME8 9TP.

Tel Med 364823 evenings only

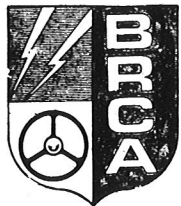

BRITISH RADIO CAR ASSOCIATION

Join your Association
and get the most out of
your racing

SAE to General Secretary
for details

T. H. Martin, 7 The Green,
Werrington, Peterborough PE4 6RT

RACE CAR NEWS from AROUND THE WORLD . . .

WRITTEN AND EDITED BY THE MOST
KNOWLEDGEABLE MODEL AUTOMO-
TIVE WRITERS, COVERING 1/8 and
1/12 GAS & ELECTRIC RACING CARS

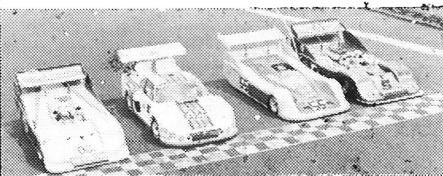

DON'T MISS AN ISSUE
ORDER YOUR SUBSCRIPTION
NOW . . .

PUBLISHED 6 TIMES PER
YEAR, ONLY \$6.50 ANNUALLY.

RACE CAR WORLD
P.O. BOX 11247, RENO, NV 89520

MICHAEL'S MODELS

646-648 HIGH ROAD
N. FINCHLEY N12 0NL
TELEPHONE 01-445-6531

ELECTRIC CARS

Tamiya XR311 Combat Vehicle R/C £46.50
Tamiya Cheetah Vehicle R/C £52.00
Tamiya 1/12th Porsche 936 R/C £39.00
Eleck Peanuts Buggy Kit R/C £44.46
Associated 3010 1/12th Kit £63.84
Associated 3000 1/12th Kit £30.83
Mardave 1/12th Electric Kit £39.94
Spectron with Speed Controller £81.77

We stock spares, fast charge cells —
chargers

CAR ENGINES

Veco 19 R/C £28.22. Veco 21 R/C £31.90.
STX 21 RE £59.75. Irvine 20 R/C £42.07
OPS21 R/C £52.13. KB21 R/C £50.59.

Phone your credit card number for same day
service. Access, Barclaycard, Carte Bleu, Eurocard,
Mastercharge, Visa, Bank America Card.

THE MODEL AIR-PORT FILTON BRISTOL

R/C CARS
ENGINES
RADIO

MAIL ORDER
ACCESS
BARCLAYCARD
HOBBYCARD

EXIT 16 — M5 Five Minutes
Closed Wednesday

134 GLOUCESTER ROAD NORTH
FILTON, BRISTOL TEL: 694541

Elegant BINDERS to take twelve copies (two year run)
of RADIO CONTROL MODEL CARS now ready. Covered
in Red Balacron (a leather-like material) with "gold"
colour title blocked on spine they have the famous
Easibind system of holding copies without damage
and permitting easy removal. Price includes postage,
packing and VAT.

£3.25 £3.75
HOME OVERSEAS

L-D Editorial & Technical Services Ltd
PO Box 30
Hemel Hempstead, Herts.

Sent direct
by
Easibind
Allow 2/3
weeks for
delivery

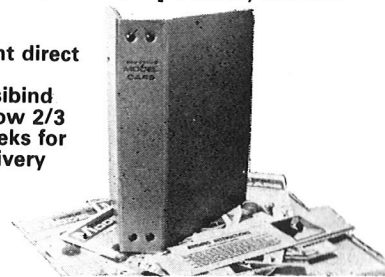

WHAT A BIND!

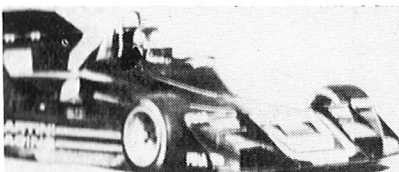

MARDAVE : P.B. : ASSOCIATED : S.G.
LECTRICAR

THE NORTH EAST RADIO CONTROL CAR CENTRE

Mon. to Sat. 9 to 5.30 except Wed.-closed. Late night
Thurs.-7.00 p.m.



PB racing products Ltd.

Downley Road, Havant, Hants. Tel. 0705-471 774

Reigning Champions of the World in
both F1 and G.T.
Let us help you to win.

PB9 INTERNATIONAL
BRITISH IS BEST

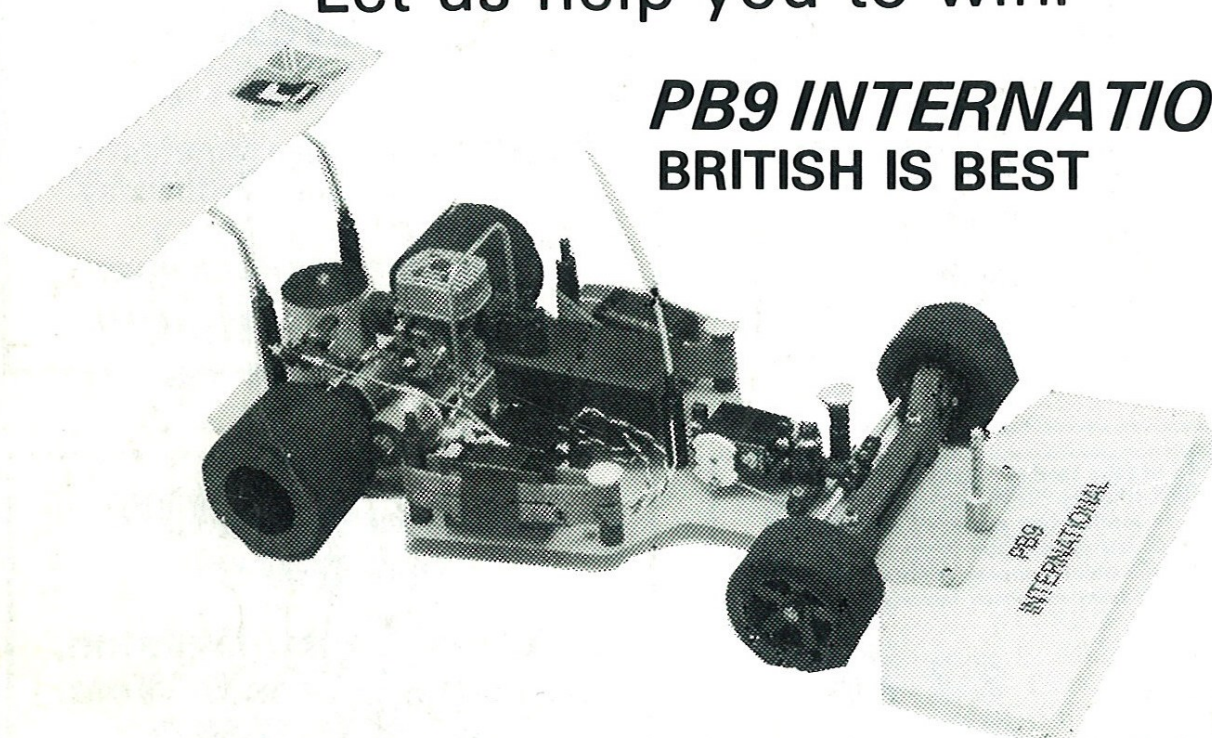

Now with Fibre Brake Disc and Metal
Brake Lining.

ACCESSORIES:—

POWER SILENCER

TRY OUR NEW
SILICONE FUEL TUBE
IN STANDARD AND
DELUXE

HIGH SPEED
MAIN BEARING

***THERE ARE MORE GOODIES TO
COME SO KEEP WATCHING !!!***